

# **PHILIPPINE BIDDING DOCUMENTS**

(As Harmonized with Development Partners)

## **Construction of River Landing at Tugal, Sultan sa Barongis, Maguindanao**

Ministry of Transportation and Communications

**Public Bidding No. 24SDF0003**

**ABC: PhP 18,606,599.27**

**Sixth Edition**

**July 2020**

# Preface

These Philippine Bidding Documents (PBDs) for the procurement of Infrastructure Projects (hereinafter referred to also as the “Works”) through Competitive Bidding have been prepared by the Government of the Philippines for use by all branches, agencies, departments, bureaus, offices, or instrumentalities of the government, including government-owned and/or -controlled corporations, government financial institutions, state universities and colleges, local government units, and autonomous regional government. The procedures and practices presented in this document have been developed through broad experience, and are for mandatory use in projects that are financed in whole or in part by the Government of the Philippines or any foreign government/foreign or international financing institution in accordance with the provisions of the 2016 revised Implementing Rules and Regulations (IRR) of Republic Act (RA) No. 9184.

The PBDs are intended as a model for admeasurements (unit prices or unit rates in a bill of quantities) types of contracts, which are the most common in Works contracting.

The Bidding Documents shall clearly and adequately define, among others: (i) the objectives, scope, and expected outputs and/or results of the proposed contract; (ii) the eligibility requirements of Bidders; (iii) the expected contract duration; and (iv) the obligations, duties, and/or functions of the winning Bidder.

Care should be taken to check the relevance of the provisions of the PBDs against the requirements of the specific Works to be procured. If duplication of a subject is inevitable in other sections of the document prepared by the Procuring Entity, care must be exercised to avoid contradictions between clauses dealing with the same matter.

Moreover, each section is prepared with notes intended only as information for the Procuring Entity or the person drafting the Bidding Documents. They shall not be included in the final documents. The following general directions should be observed when using the documents:

- a. All the documents listed in the Table of Contents are normally required for the procurement of Infrastructure Projects. However, they should be adapted as necessary to the circumstances of the particular Project.
- b. Specific details, such as the “*name of the Procuring Entity*” and “*address for bid submission,*” should be furnished in the Instructions to Bidders, Bid Data Sheet, and Special Conditions of Contract. The final documents should contain neither blank spaces nor options.
- c. This Preface and the footnotes or notes in italics included in the Invitation to Bid, BDS, General Conditions of Contract, Special Conditions of Contract, Specifications, Drawings, and Bill of Quantities are not part of the text of the final document, although they contain instructions that the Procuring Entity should strictly follow.
- d. The cover should be modified as required to identify the Bidding Documents as to the names of the Project, Contract, and Procuring Entity, in addition to date of issue.

- e. Modifications for specific Procurement Project details should be provided in the Special Conditions of Contract as amendments to the Conditions of Contract. For easy completion, whenever reference has to be made to specific clauses in the Bid Data Sheet or Special Conditions of Contract, these terms shall be printed in bold typeface on Sections I (Instructions to Bidders) and III (General Conditions of Contract), respectively.
- f. For guidelines on the use of Bidding Forms and the procurement of Foreign-Assisted Projects, these will be covered by a separate issuance of the Government Procurement Policy Board.

# TABLE OF CONTENTS

|  |           |
|--|-----------|
| <b>Glossary of Terms, Abbreviations, and Acronyms.....</b>                   | <b>5</b>  |
| <b>Section I. Invitation to Bid .....</b>                                    | <b>8</b>  |
| <b>Section II. Instructions to Bidders.....</b>                              | <b>11</b> |
| 1. Scope of Bid.....   | 12        |
| 2. Funding Information .....   | 12        |
| 3. Bidding Requirements.....   | 12        |
| 4. Corrupt, Fraudulent, Collusive, Coercive, and Obstructive Practices ..... | 12        |
| 5. Eligible Bidders.....   | 12        |
| 6. Origin of Associated Goods .....  | 13        |
| 7. Subcontracts .....  | 13        |
| 8. Pre-Bid Conference.....   | 13        |
| 9. Clarification and Amendment of Bidding Documents.....                     | 13        |
| 10. Documents Comprising the Bid: Eligibility and Technical Components ..... | 14        |
| 11. Documents Comprising the Bid: Financial Component .....                  | 14        |
| 12. Alternative Bids .....   | 14        |
| 13. Bid Prices .....   | 15        |
| 14. Bid Security.....  | 15        |
| 15. Sealing and Marking of Bids.....   | 15        |
| 16. Deadline for Submission of Bids .....                                    | 15        |
| 17. Opening and Preliminary Examination of Bids .....                        | 15        |
| 18. Detailed Evaluation and Comparison of Bids.....                          | 16        |
| 19. Post Qualification.....  | 16        |
| 20. Signing of the Contract .....  | 16        |
| <b>Section III. Bid Data Sheet.....</b>                                      | <b>17</b> |
| <b>Section IV. General Conditions of Contract .....</b>                      | <b>21</b> |
| 1. Scope of Contract.....  | 22        |
| 2. Sectional Completion of Works .....                                       | 22        |
| 3. Possession of Site.....   | 22        |
| 4. The Contractor’s Obligations.....   | 22        |
| 5. Performance Security.....   | 23        |
| 6. Site Investigation Reports .....  | 23        |
| 7. Warranty.....   | 23        |

|     |  |            |
|-----|--|------------|
| 8.  | Liability of the Contractor.....                                       | 23         |
| 9.  | Termination for Other Causes.....                                      | 23         |
| 10. | Dayworks .....   | 24         |
| 11. | Program of Work.....   | 24         |
| 12. | Instructions, Inspections and Audits .....                             | 24         |
| 13. | Advance Payment.....   | 24         |
| 14. | Progress Payments .....  | 24         |
| 15. | Operating and Maintenance Manuals.....                                 | 25         |
|     | <b>Section V. Special Conditions of Contract.....</b>                  | <b>26</b>  |
|     | <b>Section VI. Specifications .....</b>                                | <b>28</b>  |
|     | <b>Section VII. Drawings.....</b>                                      | <b>102</b> |
|     | <b>Section VIII. Bill of Quantities .....</b>                          | <b>103</b> |
|     | <b>Section IX. Checklist of Technical and Financial Documents.....</b> | <b>117</b> |

# *Glossary of Terms, Abbreviations, and Acronyms*

**ABC** – Approved Budget for the Contract.

**ARCC** – Allowable Range of Contract Cost.

**BAC** – Bids and Awards Committee.

**Bid** – A signed offer or proposal to undertake a contract submitted by a bidder in response to and in consonance with the requirements of the bidding documents. Also referred to as *Proposal* and *Tender*. (2016 revised IRR, Section 5[c])

**Bidder** – Refers to a contractor, manufacturer, supplier, distributor and/or consultant who submits a bid in response to the requirements of the Bidding Documents. (2016 revised IRR, Section 5[d])

**Bidding Documents** – The documents issued by the Procuring Entity as the bases for bids, furnishing all information necessary for a prospective bidder to prepare a bid for the Goods, Infrastructure Projects, and/or Consulting Services required by the Procuring Entity. (2016 revised IRR, Section 5[e])

**BIR** – Bureau of Internal Revenue.

**BSP** – Bangko Sentral ng Pilipinas.

**CDA** – Cooperative Development Authority.

**Consulting Services** – Refer to services for Infrastructure Projects and other types of projects or activities of the GOP requiring adequate external technical and professional expertise that are beyond the capability and/or capacity of the GOP to undertake such as, but not limited to: (i) advisory and review services; (ii) pre-investment or feasibility studies; (iii) design; (iv) construction supervision; (v) management and related services; and (vi) other technical services or special studies. (2016 revised IRR, Section 5[i])

**Contract** – Refers to the agreement entered into between the Procuring Entity and the Supplier or Manufacturer or Distributor or Service Provider for procurement of Goods and Services; Contractor for Procurement of Infrastructure Projects; or Consultant or Consulting Firm for Procurement of Consulting Services; as the case may be, as recorded in the Contract Form signed by the parties, including all attachments and appendices thereto and all documents incorporated by reference therein.

**Contractor** – is a natural or juridical entity whose proposal was accepted by the Procuring Entity and to whom the Contract to execute the Work was awarded. Contractor as used in these Bidding Documents may likewise refer to a supplier, distributor, manufacturer, or consultant.

**CPI** – Consumer Price Index.

**DOLE** – Department of Labor and Employment.

**DTI** – Department of Trade and Industry.

**Foreign-funded Procurement or Foreign-Assisted Project** –Refers to procurement whose funding source is from a foreign government, foreign or international financing institution as specified in the Treaty or International or Executive Agreement. (2016 revised IRR, Section 5[b]).

**GFI** – Government Financial Institution.

**GOCC** –Government-owned and/or –controlled corporation.

**Goods** – Refer to all items, supplies, materials and general support services, except Consulting Services and Infrastructure Projects, which may be needed in the transaction of public businesses or in the pursuit of any government undertaking, project or activity, whether in the nature of equipment, furniture, stationery, materials for construction, or personal property of any kind, including non-personal or contractual services such as the repair and maintenance of equipment and furniture, as well as trucking, hauling, janitorial, security, and related or analogous services, as well as procurement of materials and supplies provided by the Procuring Entity for such services. The term “related” or “analogous services” shall include, but is not limited to, lease or purchase of office space, media advertisements, health maintenance services, and other services essential to the operation of the Procuring Entity. (2016 revised IRR, Section 5[r])

**GOP** – Government of the Philippines.

**Infrastructure Projects** – Include the construction, improvement, rehabilitation, demolition, repair, restoration or maintenance of roads and bridges, railways, airports, seaports, communication facilities, civil works components of information technology projects, irrigation, flood control and drainage, water supply, sanitation, sewerage and solid waste management systems, shore protection, energy/power and electrification facilities, national buildings, school buildings, hospital buildings, and other related construction projects of the government. Also referred to as *civil works or works*. (2016 revised IRR, Section 5[u])

**LGUs** – Local Government Units.

**NFCC** – Net Financial Contracting Capacity.

**NGA** – National Government Agency.

**PCAB** – Philippine Contractors Accreditation Board.

**PhilGEPS** - Philippine Government Electronic Procurement System.

**Procurement Project** – refers to a specific or identified procurement covering goods, infrastructure project or consulting services. A Procurement Project shall be described, detailed, and scheduled in the Project Procurement Management Plan prepared by the agency which shall be consolidated in the procuring entity's Annual Procurement Plan. (GPPB Circular No. 06-2019 dated 17 July 2019)

**PSA** – Philippine Statistics Authority.

**SEC** – Securities and Exchange Commission.

**SLCC** – Single Largest Completed Contract.

**UN** – United Nations.



## ***Section I. Invitation to Bid***

### **Notes on the Invitation to Bid**

The Invitation to Bid (IB) provides information that enables potential Bidders to decide whether to participate in the procurement at hand. The IB shall be posted in accordance with Section 21.2 of the 2016 revised IRR of RA No. 9184.

Apart from the essential items listed in the Bidding Documents, the IB should also indicate the following:

- a. The date of availability of the Bidding Documents, which shall be from the time the IB is first advertised/posted until the deadline for the submission and receipt of bids;
- b. The place where the Bidding Documents may be acquired or the website where it may be downloaded;
- c. The deadline for the submission and receipt of bids; and
- d. Any important bid evaluation criteria.

The IB should be incorporated into the Bidding Documents. The information contained in the IB must conform to the Bidding Documents and in particular to the relevant information in the Bid Data Sheet.



## **Invitation to Bid for Construction of River Landing at Tugal, Sultan sa Barongis, Maguindanao**

1. The *Ministry of Transportation and Communications*, through the *Special Development Fund 2022* intends to apply the sum of *Eighteen Million Six Hundred Six Thousand Five Hundred Ninety-Nine Pesos and Twenty-Seven Centavos (P 18,606,599.27)* being the Approved Budget for the Contract (ABC) to payments under the contract for *public bidding no. 24SDF0003*. Bids received in excess of the ABC shall be automatically rejected at bid opening.
2. The *Ministry of Transportation and Communications* now invites bids for the above Procurement Project. Completion of the Works is required *Three Hundred Sixty days (360 days)*. Bidders should have completed a contract similar to the Project. The description of an eligible bidder is contained in the Bidding Documents, particularly, in Section II (Instructions to Bidders).
3. Bidding will be conducted through open competitive bidding procedures using non-discretionary “*pass/fail*” criterion as specified in the 2016 revised Implementing Rules and Regulations (IRR) of Republic Act (RA) No. 9184.
4. Interested bidders may obtain further information from *Ministry of Transportation and Communications* and inspect the Bidding Documents at the address given below from *8:00 am to 5:00 am*.
5. A complete set of Bidding Documents may be acquired by interested bidders on *April 16, 2024 – May 6, 2024* from given address and website/s below and upon payment of the applicable fee for the Bidding Documents, pursuant to the latest Guidelines issued by the GPPB, in the amount of *Twenty-Five Thousand Pesos Only (Php 25,000.00)*. The Procuring Entity shall allow the bidder to present its proof of payment for the fees it will be presented in person, or through electronic means.
6. The *Ministry of Transportation and Communications* will hold a Pre-Bid Conference<sup>1</sup> on *April 23, 2024 at 1:00 PM* at BLTO Conference Room, BGC, Gov. Gutierrez Avenue, Rosary Heights 7, Cotabato City, and/or through video conferencing/webcasting *via Zoom* which shall be open to prospective bidders.
7. Bids must be duly received by the BAC Secretariat through manual submission at the office address as indicated below, on or before *May 06, 2024 at 1:00 PM*. Late bids shall not be accepted.

---

<sup>1</sup> May be deleted in case the ABC is less than One Million Pesos (PhP1,000,000) where the Procuring Entity may not hold a pre-bid conference.

8. All bids must be accompanied by a bid security in any of the acceptable forms and in the amount stated in **ITB** Clause 16.
9. Bid opening shall be on ***April 23, 2024 at 1:00 PM*** at the given address below BLTO Conference Room, NTC Bldg., BGC, Gov. Gutierrez Avenue, Rosary Heights 7, Cotabato City. Bids will be opened in the presence of the bidders' representatives who choose to attend the activity.
10. The ***Ministry of Transportation and Communications*** reserves the right to reject any and all bids, declare a failure of bidding, or not award the contract at any time prior to contract award in accordance with Sections 35.6 and 41 of the 2016 revised Implementing Rules and Regulations (IRR) of RA No. 9184, without thereby incurring any liability to the affected bidder or bidders.
11. For further information, please refer to:

Name of Officer : **JAYSON V. SOLAYMAN**  
Head, SBAC Secretariat

Name of Office : Ministry of Transportation and Communications – BARMM  
Address : NTC Building, Bangsamoro Government Center,  
Gov. Gutierrez Avenue, RH 7, Cotabato City

Telephone No. : (064) 552-0055  
Email Address : **[motcbarmm.proc@gmail.com](mailto:motcbarmm.proc@gmail.com)**

12. You may visit the following websites:

For downloading of Bidding Documents: **<https://motc.bangsamoro.gov.ph>**

**MUHAMMAD AMEEN M. ABBAS**  
Deputy Minister  
Chairperson, Special Bids and Awards Committee (SBAC)

## ***Section II. Instructions to Bidders***

### **Notes on the Instructions to Bidders**

This Section on the Instruction to Bidders (ITB) provides the information necessary for bidders to prepare responsive bids, in accordance with the requirements of the Procuring Entity. It also provides information on bid submission, eligibility check, opening and evaluation of bids, post-qualification, and on the award of contract.

## **1. Scope of Bid**

The Procuring Entity, *Ministry of Transportation and Communications* invites Bids for the *Construction of River Landing at Tugal, Sultan sa Barongis, Maguindanao*, with Project Identification Number *24SDF0003*.

## **2. Funding Information**

2.1. The GOP through the source of funding as indicated below for 2022 in the amount of **P18,606,599.27**

2.2. The source of funding is: **Special Development Fund 2022**

## **3. Bidding Requirements**

The Bidding for the Project shall be governed by all the provisions of RA No. 9184 and its 2016 revised IRR, including its Generic Procurement Manual and associated policies, rules and regulations as the primary source thereof, while the herein clauses shall serve as the secondary source thereof.

Any amendments made to the IRR and other GPPB issuances shall be applicable only to the ongoing posting, advertisement, or invitation to bid by the BAC through the issuance of a supplemental or bid bulletin.

The Bidder, by the act of submitting its Bid, shall be deemed to have inspected the site, determined the general characteristics of the contracted Works and the conditions for this Project, such as the location and the nature of the work; (b) climatic conditions; (c) transportation facilities; (c) nature and condition of the terrain, geological conditions at the site communication facilities, requirements, location and availability of construction aggregates and other materials, labor, water, electric power and access roads; and (d) other factors that may affect the cost, duration and execution or implementation of the contract, project, or work and examine all instructions, forms, terms, and project requirements in the Bidding Documents.

## **4. Corrupt, Fraudulent, Collusive, Coercive, and Obstructive Practices**

The Procuring Entity, as well as the Bidders and Contractors, shall observe the highest standard of ethics during the procurement and execution of the contract. They or through an agent shall not engage in corrupt, fraudulent, collusive, coercive, and obstructive practices defined under Annex "I" of the 2016 revised IRR of RA No. 9184 or other integrity violations in competing for the Project.

## **5. Eligible Bidders**

5.1. Only Bids of Bidders found to be legally, technically, and financially capable will be evaluated.

- 5.2. The Bidder must have an experience of having completed a Single Largest Completed Contract (SLCC) that is similar to this Project, equivalent to at least fifty percent (50%) of the ABC adjusted, if necessary, by the Bidder to current prices using the PSA's CPI, except under conditions provided for in Section 23.4.2.4 of the 2016 revised IRR of RA No. 9184.

A contract is considered to be "similar" to the contract to be bid if it has the major categories of work stated in the **BDS**.

- 5.3. For Foreign-funded Procurement, the Procuring Entity and the foreign government/foreign or international financing institution may agree on another track record requirement, as specified in the Bidding Document prepared for this purpose.
- 5.4. The Bidders shall comply with the eligibility criteria under Section 23.4.2 of the 2016 IRR of RA No. 9184.

## **6. Origin of Associated Goods**

There is no restriction on the origin of Goods other than those prohibited by a decision of the UN Security Council taken under Chapter VII of the Charter of the UN.

## **7. Subcontracts**

- 7.1. The Bidder may subcontract portions of the Project to the extent allowed by the Procuring Entity as stated herein, but in no case more than fifty percent (50%) of the Project.

The Procuring Entity has prescribed that:

- a. Subcontracting is not allowed.

## **8. Pre-Bid Conference**

The Procuring Entity will hold a pre-bid conference for this Project on the specified date and time and either at its physical address *{[insert if applicable]}* and/or through videoconferencing/webcasting} as indicated in paragraph 6 of the **IB**.

## **9. Clarification and Amendment of Bidding Documents**

Prospective bidders may request for clarification on and/or interpretation of any part of the Bidding Documents. Such requests must be in writing and received by the Procuring Entity, either at its given address or through electronic mail indicated in the **IB**, at least ten (10) calendar days before the deadline set for the submission and receipt of Bids.

## **10. Documents Comprising the Bid: Eligibility and Technical Components**

- 10.1. The first envelope shall contain the eligibility and technical documents of the Bid as specified in **Section IX. Checklist of Technical and Financial Documents**.
- 10.2. If the eligibility requirements or statements, the bids, and all other documents for submission to the BAC are in foreign language other than English, it must be accompanied by a translation in English, which shall be authenticated by the appropriate Philippine foreign service establishment, post, or the equivalent office having jurisdiction over the foreign bidder's affairs in the Philippines. For Contracting Parties to the Apostille Convention, only the translated documents shall be authenticated through an apostille pursuant to GPPB Resolution No. 13-2019 dated 23 May 2019. The English translation shall govern, for purposes of interpretation of the bid.
- 10.3. A valid PCAB License is required, and in case of joint ventures, a valid special PCAB License, and registration for the type and cost of the contract for this Project. Any additional type of Contractor license or permit shall be indicated in the **BDS**.
- 10.4. A List of Contractor's key personnel (e.g., Project Manager, Project Engineers, Materials Engineers, and Foremen) assigned to the contract to be bid, with their complete qualification and experience data shall be provided. These key personnel must meet the required minimum years of experience set in the **BDS**.
- 10.5. A List of Contractor's major equipment units, which are owned, leased, and/or under purchase agreements, supported by proof of ownership, certification of availability of equipment from the equipment lessor/vendor for the duration of the project, as the case may be, must meet the minimum requirements for the contract set in the **BDS**.

## **11. Documents Comprising the Bid: Financial Component**

- 11.1. The second bid envelope shall contain the financial documents for the Bid as specified in **Section IX. Checklist of Technical and Financial Documents**.
- 11.2. Any bid exceeding the ABC indicated in paragraph 1 of the **IB** shall not be accepted.
- 11.3. For Foreign-funded procurement, a ceiling may be applied to bid prices provided the conditions are met under Section 31.2 of the 2016 revised IRR of RA No. 9184.

## **12. Alternative Bids**

Bidders shall submit offers that comply with the requirements of the Bidding Documents, including the basic technical design as indicated in the drawings and specifications. Unless there is a value engineering clause in the **BDS**, alternative Bids shall not be accepted.

### **13. Bid Prices**

All bid prices for the given scope of work in the Project as awarded shall be considered as fixed prices, and therefore not subject to price escalation during contract implementation, except under extraordinary circumstances as determined by the NEDA and approved by the GPPB pursuant to the revised Guidelines for Contract Price Escalation guidelines.

### **14. Bid Security**

14.1. The Bidder shall submit a Bid Securing Declaration or any form of Bid Security in the amount indicated in the **BDS**, which shall be not less than the percentage of the ABC in accordance with the schedule in the **BDS**.

14.2. The Bid and bid security shall be valid until *[indicate date]*. Any bid not accompanied by an acceptable bid security shall be rejected by the Procuring Entity as non-responsive.

### **15. Sealing and Marking of Bids**

Each Bidder shall submit one copy of the first and second components of its Bid.

The Procuring Entity may request additional hard copies and/or electronic copies of the Bid. However, failure of the Bidders to comply with the said request shall not be a ground for disqualification.

If the Procuring Entity allows the submission of bids through online submission to the given website or any other electronic means, the Bidder shall submit an electronic copy of its Bid, which must be digitally signed. An electronic copy that cannot be opened or is corrupted shall be considered non-responsive and, thus, automatically disqualified.

### **16. Deadline for Submission of Bids**

The Bidders shall submit on the specified date and time and either at its physical address or through online submission as indicated in paragraph 7 of the **IB**.

### **17. Opening and Preliminary Examination of Bids**

17.1. The BAC shall open the Bids in public at the time, on the date, and at the place specified in paragraph 9 of the **IB**. The Bidders' representatives who are present shall sign a register evidencing their attendance. In case videoconferencing, webcasting or other similar technologies will be used, attendance of participants shall likewise be recorded by the BAC Secretariat.

In case the Bids cannot be opened as scheduled due to justifiable reasons, the rescheduling requirements under Section 29 of the 2016 revised IRR of RA No. 9184 shall prevail.



17.2. The preliminary examination of Bids shall be governed by Section 30 of the 2016 revised IRR of RA No. 9184.

## **18. Detailed Evaluation and Comparison of Bids**

18.1. The Procuring Entity's BAC shall immediately conduct a detailed evaluation of all Bids rated "*passed*" using non-discretionary pass/fail criteria. The BAC shall consider the conditions in the evaluation of Bids under Section 32.2 of 2016 revised IRR of RA No. 9184.

18.2. If the Project allows partial bids, all Bids and combinations of Bids as indicated in the **BDS** shall be received by the same deadline and opened and evaluated simultaneously so as to determine the Bid or combination of Bids offering the lowest calculated cost to the Procuring Entity. Bid Security as required by **ITB** Clause 16 shall be submitted for each contract (lot) separately.

In all cases, the NFCC computation pursuant to Section 23.4.2.6 of the 2016 revised IRR of RA No. 9184 must be sufficient for the total of the ABCs for all the lots participated in by the prospective Bidder.

## **19. Post Qualification**

Within a non-extendible period of five (5) calendar days from receipt by the Bidder of the notice from the BAC that it submitted the Lowest Calculated Bid, the Bidder shall submit its latest income and business tax returns filed and paid through the BIR Electronic Filing and Payment System (eFPS), and other appropriate licenses and permits required by law and stated in the **BDS**.

## **20. Signing of the Contract**

The documents required in Section 37.2 of the 2016 revised IRR of RA No. 9184 shall form part of the Contract. Additional Contract documents are indicated in the **BDS**.

## ***Section III. Bid Data Sheet***

### **Notes on the Bid Data Sheet (BDS)**

The Bid Data Sheet (BDS) consists of provisions that supplement, amend, or specify in detail, information, or requirements included in the ITB found in Section II, which are specific to each procurement.

This Section is intended to assist the Procuring Entity in providing the specific information in relation to corresponding clauses in the ITB and has to be prepared for each specific procurement.

The Procuring Entity should specify in the BDS information and requirements specific to the circumstances of the Procuring Entity, the processing of the procurement, and the bid evaluation criteria that will apply to the Bids. In preparing the BDS, the following aspects should be checked:

- a. Information that specifies and complements provisions of the ITB must be incorporated.
- b. Amendments and/or supplements, if any, to provisions of the ITB as necessitated by the circumstances of the specific procurement, must also be incorporated.

# Bid Data Sheet

| ITB Clause            |  |   |  |               |                    |                                   |                      |   |   |                       |  |                                   |                    |  |   |
|-----------------------|--|---|--|---------------|--------------------|-----------------------------------|----------------------|---|---|-----------------------|--|-----------------------------------|--------------------|--|---|
| 5.2                   | <p>For this purpose, contracts similar to the Project refer to contracts which have the same major categories of work, which shall be:</p> <p>The bidder must have completed, five (5) years prior to December 2022 a single contract that is similar to the project at hand and whose value must be at least fifty percent (50%) of the ABC to be bid.</p> <p>Bidders shall include in their Bid a photocopy of Single Largest Completed Contract and the corresponding proof of completion, such as<br/>                     (i) Certificate of Final Acceptance or Completion from the bidder’s client; or<br/>                     (ii) Official Receipt issued by the bidder.</p> <p>Failure to submit a copy of Single Largest Completed Contract with proof of Completion or failure to prove the veracity of such shall be a ground for disqualification of the bidder for award and forfeiture of the bid security. For this purpose, similar contracts shall refer to contracts which have the same major categories of work as “Construction of River Landing, Construction of Fish Landing, Construction of Fish Port, Construction of Building”</p> |   |  |               |                    |                                   |                      |   |   |                       |  |                                   |                    |  |   |
| 7.1                   | <p><i>Portions of Works allowed to be subcontracted:</i></p> <p>Subcontracting is not allowed.</p>   | <p><i>Maximum Percentage allowed to be Subcontracted:</i></p> <p>Subcontracting is not allowed.</p> |  |               |                    |                                   |                      |   |   |                       |  |                                   |                    |  |   |
| 10.3                  | <p><i>For Joint Venture:</i></p> <p><b>Special PCAB License</b></p>  |   |  |               |                    |                                   |                      |   |   |                       |  |                                   |                    |  |   |
| 10.4                  | <p>The key personnel must meet the required minimum years of experience and qualifications set below. Please attach justifications such as renewed PRC licenses, biodata, and certificate of trainings as applicable to the required personnel for the contract to be bid.</p> <table border="1" style="width: 100%; border-collapse: collapse;"> <thead> <tr> <th style="width: 30%;">Key Personnel</th> <th style="width: 30%;">General Experience</th> <th style="width: 40%;">Qualifications/Relevant Trainings</th> </tr> </thead> <tbody> <tr> <td>(1) Project Engineer</td> <td>Five (5) years of experience in building construction</td> <td>With valid Professional and Regulation Commission License</td> </tr> <tr> <td>(1) Material Engineer</td> <td>Five (5) years of experience in construction</td> <td>DPWH Accredited Material Engineer</td> </tr> <tr> <td>(1) Safety Officer</td> <td>Five (5) years of experience as safety</td> <td>With Safety Training Certificate from any</td> </tr> </tbody> </table>  |   |  | Key Personnel | General Experience | Qualifications/Relevant Trainings | (1) Project Engineer | Five (5) years of experience in building construction | With valid Professional and Regulation Commission License | (1) Material Engineer | Five (5) years of experience in construction | DPWH Accredited Material Engineer | (1) Safety Officer | Five (5) years of experience as safety | With Safety Training Certificate from any |
| Key Personnel         | General Experience   | Qualifications/Relevant Trainings   |  |               |                    |                                   |                      |   |   |                       |  |                                   |                    |  |   |
| (1) Project Engineer  | Five (5) years of experience in building construction  | With valid Professional and Regulation Commission License   |  |               |                    |                                   |                      |   |   |                       |  |                                   |                    |  |   |
| (1) Material Engineer | Five (5) years of experience in construction   | DPWH Accredited Material Engineer   |  |               |                    |                                   |                      |   |   |                       |  |                                   |                    |  |   |
| (1) Safety Officer    | Five (5) years of experience as safety   | With Safety Training Certificate from any   |  |               |                    |                                   |                      |   |   |                       |  |                                   |                    |  |   |

|                        |   | officer in building construction  | training provider accredited by the Department of Labor and Employment (DOLE)                                    |           |          |                 |               |                        |   |              |                       |   |              |                        |   |            |                                 |   |                        |                         |   |                    |                      |   |                 |                          |   |                      |                         |   |               |                              |   |               |                              |   |                    |                          |   |                   |  |   |
|------------------------|---|---|--|-----------|----------|-----------------|---------------|------------------------|---|--------------|-----------------------|---|--------------|------------------------|---|------------|---------------------------------|---|------------------------|-------------------------|---|--------------------|----------------------|---|-----------------|--------------------------|---|----------------------|-------------------------|---|---------------|------------------------------|---|---------------|------------------------------|---|--------------------|--------------------------|---|-------------------|--|---|
|                        | (1) Construction Foreman  | Five (5) years of experience in building construction                       |  |           |          |                 |               |                        |   |              |                       |   |              |                        |   |            |                                 |   |                        |                         |   |                    |                      |   |                 |                          |   |                      |                         |   |               |                              |   |               |                              |   |                    |                          |   |                   |  |   |
|                        | (6) Skilled Laborer   | Five (5) years of experience in construction                                |  |           |          |                 |               |                        |   |              |                       |   |              |                        |   |            |                                 |   |                        |                         |   |                    |                      |   |                 |                          |   |                      |                         |   |               |                              |   |               |                              |   |                    |                          |   |                   |  |   |
|                        | (6) Unskilled Laborer   | Five (5) years of experience in construction                                |  |           |          |                 |               |                        |   |              |                       |   |              |                        |   |            |                                 |   |                        |                         |   |                    |                      |   |                 |                          |   |                      |                         |   |               |                              |   |               |                              |   |                    |                          |   |                   |  |   |
|                        | (1) First Aider   | Five (5) years of experience as a health personnel in building construction | With Training Certificate from any training provider accredited by the Department of Labor and Employment (DOLE) |           |          |                 |               |                        |   |              |                       |   |              |                        |   |            |                                 |   |                        |                         |   |                    |                      |   |                 |                          |   |                      |                         |   |               |                              |   |               |                              |   |                    |                          |   |                   |  |   |
| 10.5                   | <p>Please attach proof of ownership, lease or rental and photos of the equipment required for this contract.</p> <p>Failure to submit a copy of the list of minimum major equipment required with proof of ownership/lease/rental or failure to prove the veracity of such shall be a ground for disqualification of the bidder for award.</p> <p>The minimum major equipment requirements are the following:</p> <table border="1"> <thead> <tr> <th>Equipment</th> <th>Capacity</th> <th>Number of Units</th> </tr> </thead> <tbody> <tr> <td>a) Dump Truck</td> <td>8 cu.m. minimum, owned</td> <td>2</td> </tr> <tr> <td>b) Payloader</td> <td>80 hp. Minimum, owned</td> <td>1</td> </tr> <tr> <td>c) Bulldozer</td> <td>100 hp. Minimum, owned</td> <td>1</td> </tr> <tr> <td>d) Backhoe</td> <td>0.40 cu.m. 90hp, minimum, owned</td> <td>1</td> </tr> <tr> <td>e) Truck mounted crane</td> <td>10 tons, minimum, owned</td> <td>1</td> </tr> <tr> <td>f) Plate compactor</td> <td>5 hp, minimum, owned</td> <td>1</td> </tr> <tr> <td>g) Bagger Mixer</td> <td>1 bagger, minimum, owned</td> <td>1</td> </tr> <tr> <td>h) Concrete vibrator</td> <td>3.50 hp, minimum, owned</td> <td>1</td> </tr> <tr> <td>i) Bar cutter</td> <td>electric, 25 mm, min., owned</td> <td>1</td> </tr> <tr> <td>j) Bar Bender</td> <td>electric, 25 mm, min., owned</td> <td>1</td> </tr> <tr> <td>k) Welding Machine</td> <td>400 amp., minimum, owned</td> <td>1</td> </tr> <tr> <td>l) Cutting Outfit</td> <td></td> <td>1</td> </tr> </tbody> </table> |   |  | Equipment | Capacity | Number of Units | a) Dump Truck | 8 cu.m. minimum, owned | 2 | b) Payloader | 80 hp. Minimum, owned | 1 | c) Bulldozer | 100 hp. Minimum, owned | 1 | d) Backhoe | 0.40 cu.m. 90hp, minimum, owned | 1 | e) Truck mounted crane | 10 tons, minimum, owned | 1 | f) Plate compactor | 5 hp, minimum, owned | 1 | g) Bagger Mixer | 1 bagger, minimum, owned | 1 | h) Concrete vibrator | 3.50 hp, minimum, owned | 1 | i) Bar cutter | electric, 25 mm, min., owned | 1 | j) Bar Bender | electric, 25 mm, min., owned | 1 | k) Welding Machine | 400 amp., minimum, owned | 1 | l) Cutting Outfit |  | 1 |
| Equipment              | Capacity  | Number of Units   |  |           |          |                 |               |                        |   |              |                       |   |              |                        |   |            |                                 |   |                        |                         |   |                    |                      |   |                 |                          |   |                      |                         |   |               |                              |   |               |                              |   |                    |                          |   |                   |  |   |
| a) Dump Truck          | 8 cu.m. minimum, owned  | 2   |  |           |          |                 |               |                        |   |              |                       |   |              |                        |   |            |                                 |   |                        |                         |   |                    |                      |   |                 |                          |   |                      |                         |   |               |                              |   |               |                              |   |                    |                          |   |                   |  |   |
| b) Payloader           | 80 hp. Minimum, owned   | 1   |  |           |          |                 |               |                        |   |              |                       |   |              |                        |   |            |                                 |   |                        |                         |   |                    |                      |   |                 |                          |   |                      |                         |   |               |                              |   |               |                              |   |                    |                          |   |                   |  |   |
| c) Bulldozer           | 100 hp. Minimum, owned  | 1   |  |           |          |                 |               |                        |   |              |                       |   |              |                        |   |            |                                 |   |                        |                         |   |                    |                      |   |                 |                          |   |                      |                         |   |               |                              |   |               |                              |   |                    |                          |   |                   |  |   |
| d) Backhoe             | 0.40 cu.m. 90hp, minimum, owned   | 1   |  |           |          |                 |               |                        |   |              |                       |   |              |                        |   |            |                                 |   |                        |                         |   |                    |                      |   |                 |                          |   |                      |                         |   |               |                              |   |               |                              |   |                    |                          |   |                   |  |   |
| e) Truck mounted crane | 10 tons, minimum, owned   | 1   |  |           |          |                 |               |                        |   |              |                       |   |              |                        |   |            |                                 |   |                        |                         |   |                    |                      |   |                 |                          |   |                      |                         |   |               |                              |   |               |                              |   |                    |                          |   |                   |  |   |
| f) Plate compactor     | 5 hp, minimum, owned  | 1   |  |           |          |                 |               |                        |   |              |                       |   |              |                        |   |            |                                 |   |                        |                         |   |                    |                      |   |                 |                          |   |                      |                         |   |               |                              |   |               |                              |   |                    |                          |   |                   |  |   |
| g) Bagger Mixer        | 1 bagger, minimum, owned  | 1   |  |           |          |                 |               |                        |   |              |                       |   |              |                        |   |            |                                 |   |                        |                         |   |                    |                      |   |                 |                          |   |                      |                         |   |               |                              |   |               |                              |   |                    |                          |   |                   |  |   |
| h) Concrete vibrator   | 3.50 hp, minimum, owned   | 1   |  |           |          |                 |               |                        |   |              |                       |   |              |                        |   |            |                                 |   |                        |                         |   |                    |                      |   |                 |                          |   |                      |                         |   |               |                              |   |               |                              |   |                    |                          |   |                   |  |   |
| i) Bar cutter          | electric, 25 mm, min., owned  | 1   |  |           |          |                 |               |                        |   |              |                       |   |              |                        |   |            |                                 |   |                        |                         |   |                    |                      |   |                 |                          |   |                      |                         |   |               |                              |   |               |                              |   |                    |                          |   |                   |  |   |
| j) Bar Bender          | electric, 25 mm, min., owned  | 1   |  |           |          |                 |               |                        |   |              |                       |   |              |                        |   |            |                                 |   |                        |                         |   |                    |                      |   |                 |                          |   |                      |                         |   |               |                              |   |               |                              |   |                    |                          |   |                   |  |   |
| k) Welding Machine     | 400 amp., minimum, owned  | 1   |  |           |          |                 |               |                        |   |              |                       |   |              |                        |   |            |                                 |   |                        |                         |   |                    |                      |   |                 |                          |   |                      |                         |   |               |                              |   |               |                              |   |                    |                          |   |                   |  |   |
| l) Cutting Outfit      |   | 1   |  |           |          |                 |               |                        |   |              |                       |   |              |                        |   |            |                                 |   |                        |                         |   |                    |                      |   |                 |                          |   |                      |                         |   |               |                              |   |               |                              |   |                    |                          |   |                   |  |   |
| 12                     | <p><i>Value Engineering Clause:</i></p> <p><b>Not allowed</b></p>   |   |  |           |          |                 |               |                        |   |              |                       |   |              |                        |   |            |                                 |   |                        |                         |   |                    |                      |   |                 |                          |   |                      |                         |   |               |                              |   |               |                              |   |                    |                          |   |                   |  |   |
| 15.1                   | <p>The bid security shall be in the form of a Bid Securing Declaration or any of the following forms and amounts:</p>   |   |  |           |          |                 |               |                        |   |              |                       |   |              |                        |   |            |                                 |   |                        |                         |   |                    |                      |   |                 |                          |   |                      |                         |   |               |                              |   |               |                              |   |                    |                          |   |                   |  |   |

|      |   |
|------|---|
|      | <p>a. The amount of not less than <b>Three Hundred Seventy-Two Thousand One Hundred Thirty-One Pesos and Ninety-Nine Centavos (P372,131.99)</b>, if bid security is in cash, cashier's/manager's check, bank draft/guarantee or irrevocable letter of credit;</p> <p>b. The amount of not less than <b>Nine Hundred Thirty Thousand Three Hundred Twenty-Nine Pesos and Ninety-Six Centavos (P 930,329.96)</b> if bid security is in Surety Bond; or</p> <p>c. Any combination of the foregoing proportionate to the share of form with respect to total amount of security.</p> <p>In lieu of a bid security mentioned above, the bidder may submit a <b>Bid Securing Declaration</b> that is an undertaking which states, among others, that the bidder shall enter in to contract with the procuring entity and furnish the required performance security within ten (10) calendar days, or less, as indicated in the Bidding Documents, from receipt of the Notice of Award, and committing to pay the corresponding fine and be suspended for a period of time from being qualified to participate in any government procurement activity in the event it violates any of the conditions stated therein as required in the guidelines issued by the GPPB.</p> <p>In no case shall bid security or Bid Securing Declaration be returned later than the expiration of the bid validity period indicated in the Bidding Documents, unless it has been extended in accordance with Section 28.2 of the IRR.</p> <p>The Bid Securing Declaration Form is in Section IX. Bidding Form.</p> |
| 19.2 | <p>Partial bids:</p> <p>Not allowed</p>   |
| 20   | <p><i>Other appropriate licenses and permits required:</i></p> <p><b>None</b></p>   |
| 21   | <p>Additional contract documents relevant to the Project that may be required by existing laws and/or the Procuring Entity, such as construction schedule and S-curve, manpower schedule, construction methods, equipment utilization schedule, construction safety and health program approved by the DOLE, and other acceptable tools of project scheduling.</p>  |

## ***Section IV. General Conditions of Contract***

### **Notes on the General Conditions of Contract**

The General Conditions of Contract (GCC) in this Section, read in conjunction with the Special Conditions of Contract in Section V and other documents listed therein, should be a complete document expressing all the rights and obligations of the parties.

Matters governing performance of the Contractor, payments under the contract, or matters affecting the risks, rights, and obligations of the parties under the contract are included in the GCC and Special Conditions of Contract.

Any complementary information, which may be needed, shall be introduced only through the Special Conditions of Contract.

## 1. Scope of Contract

This Contract shall include all such items, although not specifically mentioned, that can be reasonably inferred as being required for its completion as if such items were expressly mentioned herein. All the provisions of RA No. 9184 and its 2016 revised IRR, including the Generic Procurement Manual, and associated issuances, constitute the primary source for the terms and conditions of the Contract, and thus, applicable in contract implementation. Herein clauses shall serve as the secondary source for the terms and conditions of the Contract.

This is without prejudice to Sections 74.1 and 74.2 of the 2016 revised IRR of RA No. 9184 allowing the GPPB to amend the IRR, which shall be applied to all procurement activities, the advertisement, posting, or invitation of which were issued after the effectivity of the said amendment.

## 2. Sectional Completion of Works

If sectional completion is specified in the **Special Conditions of Contract (SCC)**, references in the Conditions of Contract to the Works, the Completion Date, and the Intended Completion Date shall apply to any Section of the Works (other than references to the Completion Date and Intended Completion Date for the whole of the Works).

## 3. Possession of Site

4.1. The Procuring Entity shall give possession of all or parts of the Site to the Contractor based on the schedule of delivery indicated in the **SCC**, which corresponds to the execution of the Works. If the Contractor suffers delay or incurs cost from failure on the part of the Procuring Entity to give possession in accordance with the terms of this clause, the Procuring Entity's Representative shall give the Contractor a Contract Time Extension and certify such sum as fair to cover the cost incurred, which sum shall be paid by Procuring Entity.

4.2. If possession of a portion is not given by the above date, the Procuring Entity will be deemed to have delayed the start of the relevant activities. The resulting adjustments in contract time to address such delay may be addressed through contract extension provided under Annex "E" of the 2016 revised IRR of RA No. 9184.

## 4. The Contractor's Obligations

The Contractor shall employ the key personnel named in the Schedule of Key Personnel indicating their designation, in accordance with **ITB** Clause 10.3 and specified in the **BDS**, to carry out the supervision of the Works.

The Procuring Entity will approve any proposed replacement of key personnel only if their relevant qualifications and abilities are equal to or better than those of the personnel listed in the Schedule.

## **5. Performance Security**

- 5.1. Within ten (10) calendar days from receipt of the Notice of Award from the Procuring Entity but in no case later than the signing of the contract by both parties, the successful Bidder shall furnish the performance security in any of the forms prescribed in Section 39 of the 2016 revised IRR.
- 5.2. The Contractor, by entering into the Contract with the Procuring Entity, acknowledges the right of the Procuring Entity to institute action pursuant to RA No. 3688 against any subcontractor be they an individual, firm, partnership, corporation, or association supplying the Contractor with labor, materials and/or equipment for the performance of this Contract.

## **6. Site Investigation Reports**

The Contractor, in preparing the Bid, shall rely on any Site Investigation Reports referred to in the SCC supplemented by any information obtained by the Contractor.

## **7. Warranty**

- 7.1. In case the Contractor fails to undertake the repair works under Section 62.2.2 of the 2016 revised IRR, the Procuring Entity shall forfeit its performance security, subject its property(ies) to attachment or garnishment proceedings, and perpetually disqualify it from participating in any public bidding. All payables of the GOP in his favor shall be offset to recover the costs.
- 7.2. The warranty against Structural Defects/Failures, except that occasioned-on force majeure, shall cover the period from the date of issuance of the Certificate of Final Acceptance by the Procuring Entity. Specific duration of the warranty is found in the SCC.

## **8. Liability of the Contractor**

Subject to additional provisions, if any, set forth in the SCC, the Contractor's liability under this Contract shall be as provided by the laws of the Republic of the Philippines.

If the Contractor is a joint venture, all partners to the joint venture shall be jointly and severally liable to the Procuring Entity.

## **9. Termination for Other Causes**

Contract termination shall be initiated in case it is determined *prima facie* by the Procuring Entity that the Contractor has engaged, before, or during the implementation of the contract, in unlawful deeds and behaviors relative to contract acquisition and implementation, such as, but not limited to corrupt, fraudulent, collusive, coercive, and obstructive practices as stated in ITB Clause 4.



## **10. Dayworks**

Subject to the guidelines on Variation Order in Annex “E” of the 2016 revised IRR of RA No. 9184, and if applicable as indicated in the SCC, the Dayworks rates in the Contractor’s Bid shall be used for small additional amounts of work only when the Procuring Entity’s Representative has given written instructions in advance for additional work to be paid for in that way.

## **11. Program of Work**

11.1. The Contractor shall submit to the Procuring Entity’s Representative for approval the said Program of Work showing the general methods, arrangements, order, and timing for all the activities in the Works. The submissions of the Program of Work are indicated in the SCC.

11.2. The Contractor shall submit to the Procuring Entity’s Representative for approval an updated Program of Work at intervals no longer than the period stated in the SCC. If the Contractor does not submit an updated Program of Work within this period, the Procuring Entity’s Representative may withhold the amount stated in the SCC from the next payment certificate and continue to withhold this amount until the next payment after the date on which the overdue Program of Work has been submitted.

## **12. Instructions, Inspections and Audits**

The Contractor shall permit the GOP or the Procuring Entity to inspect the Contractor’s accounts and records relating to the performance of the Contractor and to have them audited by auditors of the GOP or the Procuring Entity, as may be required.

## **13. Advance Payment**

The Procuring Entity shall, upon a written request of the Contractor which shall be submitted as a Contract document, make an advance payment to the Contractor in an amount not exceeding fifteen percent (15%) of the total contract price, to be made in lump sum, or at the most two installments according to a schedule specified in the SCC, subject to the requirements in Annex “E” of the 2016 revised IRR of RA No. 9184.

## **14. Progress Payments**

The Contractor may submit a request for payment for Work accomplished. Such requests for payment shall be verified and certified by the Procuring Entity’s Representative/Project Engineer. Except as otherwise stipulated in the SCC, materials and equipment delivered on the site but not completely put in place shall not be included for payment.

## **15. Operating and Maintenance Manuals**

- 15.1. If required, the Contractor will provide “as built” Drawings and/or operating and maintenance manuals as specified in the **SCC**.
- 15.2. If the Contractor does not provide the Drawings and/or manuals by the dates stated above, or they do not receive the Procuring Entity’s Representative’s approval, the Procuring Entity’s Representative may withhold the amount stated in the **SCC** from payments due to the Contractor.

## ***Section V. Special Conditions of Contract***

### **Notes on the Special Conditions of Contract**

Similar to the BDS, the clauses in this Section are intended to assist the Procuring Entity in providing contract-specific information in relation to corresponding clauses in the GCC found in Section IV.

The Special Conditions of Contract (SCC) complement the GCC, specifying contractual requirements linked to the special circumstances of the Procuring Entity, the Procuring Entity's country, the sector, and the Works procured. In preparing this Section, the following aspects should be checked:

- a. Information that complements provisions of the GCC must be incorporated.
- b. Amendments and/or supplements to provisions of the GCC as necessitated by the circumstances of the specific purchase, must also be incorporated.

However, no special condition which defeats or negates the general intent and purpose of the provisions of the GCC should be incorporated herein.

## Special Conditions of Contract

| GCC Clause |  |
|------------|--|
| 2          | <p><i>Sectional completion:</i></p> <p><b>None</b></p>   |
| 4.1        | The Procuring Entity shall give possession of all parts of the site to the contractor upon commencement of the project.  |
| 6          | <p>The site investigation reports are: <i>Applicable</i></p> <p><i>The contractor is required to conduct a Site investigation and Secure a Certificate of Appearance duly signed by the end-user.</i></p>  |
| 7.2        | <p><i>Permanent structures: Fifteen (15) years</i></p> <p>Buildings of types 4 and 5 as classified under the National Building Code of the Philippines and other structures made of steel, iron, or concrete which comply with relevant structural codes (e.g., DPWH Standard Specifications), such as, but not limited to, steel/concrete bridges, flyovers, aircraft movement areas, ports, dams, tunnels, filtration and treatment plants, sewerage systems, power plants, transmission and communication towers, railway system, and other similar permanent structures.</p> |
| 10         | Day works are applicable at the rate shown in the Contractor's original Bid.   |
| 11.1       | The Contractor shall submit the Program of Work to the Procuring Entity's Representative within <i>10</i> days of delivery of the Notice of Award.   |
| 11.2       | The amount to be withheld for late submission of an updated Program of Work is <b>(1%) of the progress billing.</b>  |
| 13         | The amount of the advance payment is <i>15% of the contract amount.</i>  |
| 14         | No further instructions  |
| 15.1       | <p>The date by which operating and maintenance manuals are required is <i>[N/A]</i>.</p> <p>The date by which "as built" drawings are required is <b>15 days after project completion.</b></p>   |
| 15.2       | The amount to be withheld for failing to produce "as built" drawings and/or operating and maintenance manuals by the date required is <b>5% of the contract amount.</b>  |

## ***Section VI. Specifications***

### **Notes on Specifications**

A set of precise and clear specifications is a prerequisite for Bidders to respond realistically and competitively to the requirements of the Procuring Entity without qualifying or conditioning their Bids. In the context of international competitive bidding, the specifications must be drafted to permit the widest possible competition and, at the same time, present a clear statement of the required standards of workmanship, materials, and performance of the goods and services to be procured. Only if this is done will the objectives of economy, efficiency, and fairness in procurement be realized, responsiveness of Bids be ensured, and the subsequent task of bid evaluation facilitated. The specifications should require that all goods and materials to be incorporated in the Works be new, unused, of the most recent or current models, and incorporate all recent improvements in design and materials unless provided otherwise in the Contract.

Samples of specifications from previous similar projects are useful in this respect. The use of metric units is mandatory. Most specifications are normally written specially by the Procuring Entity or its representative to suit the Works at hand. There is no standard set of Specifications for universal application in all sectors in all regions, but there are established principles and practices, which are reflected in these PBDs.

There are considerable advantages in standardizing General Specifications for repetitive Works in recognized public sectors, such as highways, ports, railways, urban housing, irrigation, and water supply, in the same country or region where similar conditions prevail. The General Specifications should cover all classes of workmanship, materials, and equipment commonly involved in construction, although not necessarily to be used in a particular Works Contract. Deletions or addenda should then adapt the General Specifications to the particular Works.

Care must be taken in drafting specifications to ensure that they are not restrictive. In the specification of standards for goods, materials, and workmanship, recognized international standards should be used as much as possible. Where other particular standards are used, whether national standards or other standards, the specifications should state that goods, materials, and workmanship that meet other authoritative standards, and which ensure substantially equal or higher quality than the standards mentioned, will also be acceptable. The following clause may be inserted in the SCC.

#### **Sample Clause: Equivalency of Standards and Codes**

Wherever reference is made in the Contract to specific standards and codes to be met by the goods and materials to be furnished, and work performed or tested, the provisions of the latest current edition or revision of the relevant standards and codes in effect shall apply, unless otherwise expressly stated in the Contract. Where such standards and codes are national, or relate to a particular country or region, other authoritative standards that ensure a substantially equal or higher quality than the standards and codes specified will be accepted subject to the Procuring Entity's Representative's prior review and written consent. Differences between the standards specified and the proposed alternative standards shall be fully described in writing by the Contractor and submitted to the Procuring Entity's Representative at least twenty-eight (28) days prior to the date when the Contractor desires the Procuring Entity's Representative's consent. In the event the Procuring Entity's Representative determines that such proposed deviations do not ensure substantially equal or higher quality, the Contractor shall comply with the standards specified in the documents.

These notes are intended only as information for the Procuring Entity or the person drafting the Bidding Documents. They should not be included in the final Bidding Documents.

## **1.0 GENERAL REQUIREMENTS**

### **1.1 Scope of Work**

This section shall include mobilization and demobilization of Contractor's plant, equipment, material and employee to the site; construction of the Contractor's office and facilities; compliance with the contract requirements.

This section shall include the furnishing of labor, materials, transportation, tools, supplies plant, equipment and appurtenance to complete satisfactorily the construction of the proposed subproject.

### **1.2 Mobilization and Demobilization**

The contractor upon receipt of the notice to proceed shall immediately mobilize and transport his plant, equipment, materials and employees to the site and demobilized or remove the same at the completion of the subproject.

### **1.3 Contractors field office and facilities**

#### **1.3.1 Field Office**

During the performance of the contract, the contractor shall construct and maintain a field office and facilities at the site of the work at which he or his authorized agent shall be holding office and all times, while the work is in progress. The location, dimensions and layout of such field office shall be subject to approval, Construction shanties, sheds and temporary facilities provided as requires for the contractor's convenience shall be maintain in good condition and neat appearance including finishes as required.

#### **1.3.2 Temporary Light and Power**

The contractor shall provide and maintain temporary electrical service including installation of temporary power and lighting within the construction site. The electrical service shall be adequate in capacity to supply power to construction tools and equipment without over-loading the temporary equipment and wiring for power and lighting shall be in accordance with the applicable provisions with the local governing codes. At the completion of the construction work all temporary wiring, lighting, equipment and devices shall be removed.

#### **1.3.3 Temporary Toilet**

The construction shall provide and maintain a sanitary condition enclosed toilet for the use of all construction personnel located within the contract limits, complete with fixtures, water and sewer connections and all appurtenances.

Installation shall be in accordance with all applicable codes and regulations of local authorities having jurisdiction thereof. Upon completion of work, temporary toilet and their appurtenances shall be removed.

#### 1.3.4 Temporary Water Service

The Contractor shall provide and maintain temporary water supply services, complete with necessary connections and appurtenances. Installed water supply lines shall be used as a source of water for construction purposes subject to the approval of the Project Manager. The Contractor shall pay the cost of operation, maintenance and restoration of the water system. All temporary water service including equipment and piping shall be removed upon the completion of work and all worn out and damaged parts of the permanent system shall be replaced and restored in first class condition equal to new.

#### 1.3.5 Security

The Contractor shall provide sufficient security in the construction site to prevent illegal entry or work damaged during in ghts; holidays and other period when work is not executed; and during working hours. The Contractor shall take ample precautions against fire and keeping away flammable materials, and ensure that such materials are properly handled and stored. Fires shall not be built within the area of construction, except when permitted by the Project Manager.

### 1.4 Compliance with Contract Requirements

#### 1.4.1 Control of on-Site Construction

Prior to start of any definable feature of the work, the Contractor must perform the necessary inspection to include as follows:

- (1) Review of contract documents to make sure that material, equipment and products have been tested, submitted and approved.
- (2) Physical examination of materials and equipment to assure its conformity to the specification, plans, shop drawing and other data.
- (3) As soon as the work has been started the Contractor shall conduct initial inspection to check and review the workmanship in compliance with the contract requirements for a particular item of work.
- (4) The Contractor shall perform these inspections on a regular basis to assure continuing compliance with the contract requirements until completion of a particular type of work.



#### 1.4.2 Pre-Construction Meetings

Prior to the start of construction, Contractor's material men whose presence is required must attend pre construction meetings as directed for the purpose of discussing the execution of work. In this conference, the contractor determines the necessary precautions in mitigating the effect of construction on environmental aspect and medical services.

#### 1.4.3 Progress Meetings

Progress meetings shall be called upon by the following for the purpose of discussing the implementation of the work:

- (1) When called upon by the Project Manager of LGU/DOH or his representative for the purpose of discussing the execution of work. Contractor's material men whose presence is necessary or requested must attend the progress meetings. Each of such meetings shall be held at the time and place designated by the project Manager or his representative. Decisions and instructions agreed by these meetings should be binding and conclusive on the contract. Minutes of these meetings shall be recorded and reasonable number of copies shall be furnished to the contractor for distribution to various material men and vendors involved.
- (2) The contractor may also call for a progress meeting for the purpose of coordinating, expediting and scheduling the work. In such meeting Contractor's material men or vendors, whose presence is necessary or requested to attend.

#### 1.4.4 Progress Report

The contractor shall prepare and submit progress reports the project manager every 30 days after the start of the project up to its completion, showing the work completed work remaining to be done, status of construction equipment and materials at the site, as stipulated in section 4 of the General Conditions of Contract.

#### 1.4.5 Survey Data

The contractor shall layout his work from established base lines and benchmark indicated in the drawing and shall be responsible for all measurement in

connection therewith. The contractor shall furnish, at his own expense, all stakes, templates, platforms, equipment, tools, materials and labor as maybe required in laying out any part of the work, out of established base lines and benchmark. It shall be the responsibility of the contractor to maintain and preserve all stakes and other marks until he is authorized to remove them. If the contractor through his negligence prior to the authorized removal destroys such marks, they shall be replaced at the expense of the Contractor.

#### 1.4.6 Shop Drawing

The Contractor shall submit and furnish shop drawings and samples accompanied with the provision of the conditions of contract. The term “shop Drawing” as used here in shall be understood to include detailed design calculations, construction drawings, lists, Graphs supplemental specifications and others.

- (1) Transmittal forms shall be filled out in typewritten or ink with no alterations or inter line actions unless initialized dates before submittal. Shop drawings shall be submitted as the same size as the contract drawing when practicable, but in no case, it shall exceed dimension of the contract drawings. The contractor shall make preliminary check of all shop drawings for compliance with the contract documents and he shall stamp each print with statements of compliance with the requirements. The Contractor may authorize his supplier to deal with the project manager with regard to the shop drawings; however ultimate responsibility for accuracy and completeness in the submittal shall remain with the contractor.
- (2) The said shop drawing and transmittal shall be submitted at time sufficiently early, to allow review of the same by the project manager and to accommodate the rate of construction progress required under the contract. The contractor shall submit print copies of show drawing with transmittal forms, and copies of brochures with transmittal forms as required by the Project Manager.
- (3) Any shop drawings and samples submitted not accompanied by transmittal forms of where all applicable items on the forms are not completed would be return for resubmission. The project manager who will check and evaluate mentioned shop drawing would retain copy for his file and return the rest to the Contractor with notation. Returned shop drawing marked “No Exception Taken” or “Make Corrections Noted”, means formal revision of said drawings will not be required. If it is marked “Amend Resubmit” or “Rejected-Resubmit”. The contractor shall revise said drawings and shall submit revised drawing to the project manager.

- (4) The project manager shall process the submission and indicate the appropriate drawing on the shop drawing and transmittal forms. Construction of an item shall not commence before the project manager has reviewed the pertinent shop drawing and return it to the contractor, marked as mentioned above. Revisions indicated on shop drawing shall be considered as changes necessary to meet the requirements of the contract drawings and specifications, and shall not be taken as the bases of claims of extra work. The contractor shall have no claim for damages or extension of time due to any delay, resulting from having contractors make the required revisions, unless review by the project manager was delayed beyond reasonable period of time and unless the contractor can establish that such delay in revision in delay of the project.
- (5) Resubmitted procedure shall allow the same procedure as the initial submittal.

#### 1.4.7 Construction Photographs

The contractor shall take photographs during the process of the work once a month, all taken as directed by the project manager. At the completion of the project, final photographs shall be sent to the LGU or the project manager. The photographs shall be neatly labeled, dated and identified in a little box in the lower right-hand corner, showing the date of the exposure, project name, location and direction of view.

All negatives shall be retained by the contractor until the completion of the work at which time they shall become the property of the LGU.

#### 1.4.8 Cleaning-up

The contractor shall at all times keep the construction area including storage area used by him free accumulations of waste materials or rubbish. Upon completion of construction, the contractor shall leave the work and premises in clean, neat and workmanlike conditions satisfactory to the LGU.

#### 1.4.9 Documents to be submitted

The contractor shall submit the following documents prior to final payment and before issuance of final certificate of payment in accordance with the provisions of the conditions contract.

- (1) The guarantee required by the conditions of contract and any other extended guarantees stated in the technical specifications of the specifications.
- (2) A set of As-Built drawing shall be submitted showing accurate record of changes or deviations from the contract documents and the shop drawings indicating the work as actually installed. Records shall be

arranged in order, In accordance with various sections of the specifications and properly indexed with certifications of endorsement thereof, that each of the revised print of drawings and specifications are complete and accurate. Prior to the application of final payment, and as a condition to its approval by the project manager of LGU, the contractor shall deliver the records, drawings and specifications arranged in proper order, indexed and endorsed herein specified.

### 1.5 Method of Measurement and Basis of Payment

Cost incurred in providing and maintaining contractor's field office, temporary light power. Temporary toilet, water and security services, including cost of mobilization and demobilization, and cost incurred in the compliance of contract requirements shall not be measured and paid separately, same shall be deemed to be included in the cost of other items work, as part of the contractor's construction overheads.

## 2.0 SITE WORK

### 2.1 Scope

The section includes site clearing, earthwork and site drainage and utilities construction of septic tank, placenta pit, septic vault for sharp objects in accordance with the drawing and specification.

### 2.2 Applicable Documents

The latest edition of the following standard and specifications shall form part of these specifications:

|       |  |
|-------|--|
| ASTM  | American Society for Testing and Materials   |
| C131  | Resistance to Abrasion of Small Size Coarse Aggregate by use of the Los Angeles Machine      |
| D698  | Moisture-Density Relations of soils using 5.5 lb. (2.5 kg.) Rammer and 12 in (304.8 mm) Drop |
| D1556 | Density of Soil in place by the Sand Cone Method   |
| D1557 | Moisture-Density Relations of Soils using 10 lb. (4.5 kg) Rammer and 18 in (475 mm) Drop     |
| D2487 | Classification of soils for Engineering Purposes   |
| C-14  | Concrete Sewer, Storm Drain and Culvert pipe   |

|            |                                    |
|------------|------------------------------------|
| C-76/C-497 | Class II Reinforced Concrete Pipes |
| A-74       | Cast Iron Soil Pipes and Fittings  |

Other pipes shall conform to the latest ASTM requirements.

## 2.3 Material Requirements:

### 2.3.1 Selected Fill Material

Selected fill materials shall consist of pit run gravel, disintegrated rock sand and or other similar materials. The material shall not contain more than 35% passing the No. 200 sieve; and fraction of the material passing the No. 40 sieve shall have a liquid limit not greater than 35 and plasticity index not greater than 12.

### 2.3.2 Gravel Fill

Gravel fill shall consist of hard durable particles or fragments of stones or gravel. It shall be clean and free from vegetable matters, lumps or balls of clay and other deleterious materials. The proportion of the material passing the 0.075 mm (No. 200) sieve shall not be greater than 0.66 (two-thirds) of the fraction passing the 0.425 mm (No. 40) sieve. The fraction passing the 0.425 mm (No. 40) sieve shall have a liquid limit of not more than 25 plasticity indexes of not more than 6 as Gravel fill shall consist of hard durable particles or fragments of stones or gravel. It must be determined by AASHTO T89 and T90. Gravel bedding 100 mm (4") in depth or as shown on the drawing shall be placed, spread and compacted through tamping and underneath footing, slabs, on fill and slabs on grade.

### 2.3.3 Base and Sub-base Course

Aggregate sub-base shall consist of pit run gravel, talus rock disintegrated granite, sand, shale cinders, coral and other similar materials or additional filler for blending, selected under the direction of the consultant. The maximum dimension of any particle shall not be greater than two-thirds of the required thickness of the layer in which it is to be placed. Over-sized materials if present shall be removed at the pit with screens, or hand picking. If necessary, to obtain proper uniformity, mixing shall blend additional filler. The fraction to aggregate sub-based materials including any additional filler passing the 0.075 mm (No. 200) sieve shall not be more than 2/3 of that passing the 0.425 mm (no. 40) sieve. The fraction passing the 0.425 mm sieve shall have a liquid limit not greater than 25 and plasticity index not more than 6.

#### 2.3.4 Concrete for Site Work

Concrete materials for the site work shall be in accordance with Section 3, concrete of these specifications. Cement shall be proportion as follows:

##### Description of Structures Compressive Strength

- |  |                                |
|--|--------------------------------|
| 1.) For sidewalks, walkways,<br>catch basins and man holes | 1.72 Mpa (2500 psi) at 28 days |
| 2.) Septic Tank/Placenta pit                               | 20.7 Mpa (3000 psi) at 28 days |

#### 2.4 Construction Requirements

##### 2.4.1 Earthwork

###### 1. Site Demolition

All superficial obstruction shall be demolished and removed from the site to disposal areas approved by the consultant.

###### 2. Clearing and grubbing

###### (a.) Clearing

All areas within the structure or related construction has to be accomplished, shall be completely cleared of matted roots, trees brush, snags, vegetation, rubbish, and other objectionable matters. All combustible materials from clearing operation shall be completely burned or removed from the site of work or otherwise disposal off as directed by the project manager. All materials to be burned shall be piled neatly and when in suitable condition shall be burned completely. Piling for burning shall be done in such a manner and location as cause least fire risk. All burning shall be thorough that the cleared materials can be reduced to ashes. The contractor shall at all times take special precautions to prevent fire from spreading and shall have available at all times, suitable equipment and supplies, for use in preventing and fighting fires.

###### b.) Grubbing

Grubbing shall consist of the removal of tree stumps, brush and rubbish from the work areas to be occupied by permanent structures from other areas within the indicated clearing limits as directed by the consultant. Trees and shrubs to be retained shall be protected properly from damage. Stumps shall be removed entirely. Roots and matted roots shall be grubbed and cut to at least 450 mm below the existing surface.

### 3. Structural Excavation

All excavations shall be performed by the contractor to the excavation lines, grades and slopes and profiles shown in the drawings, or as directed by the project manager. All excavation shall be performed in the dry condition, unless otherwise approved by the project manager.

#### (a) Excavation for Structure and Trenches

Excavations carried out below the depth indicated on the drawing without the approval of the project manager shall be refilled to the proper grade with thoroughly compacted suitable fill materials to the satisfaction of the project manager except for footing excavation where concrete shall be replaced to the bottom of the excavation. Additional work for this nature shall be at the contractor's expense. Where an existing structure lies adjacent to excavation line, adequate shoring and bracing shall be provided to prevent damage to persons and properties. Shoring, bracing and sheeting shall be removed in a manner to prevent caving-in. the grading in the vicinity of excavated areas shall be done to prevent surface water from running into excavations and embankments. Water pumped from excavations shall be diverted to suitable disposal points. Trenches for pipelines shall be excavated along straight lines and provided with minimum of 150 mm space between the outside of the pipe and the side of the trench or bracing. Additional excavation shall be made for each joint to allow for joining.

Trench excavation, other than rock shall be excavated at least 50mm above final invert grade; the remainder of the excavation shall be shaped manually, and graded to provide uniform bearing when the pipe is laid. Unless otherwise indicated, backfill cover over water sewer, drainage and electrical conduit pipes shall not be less than 300 mm depth.

#### (b) Excavation Under Pavement and Concrete Slabs

The entire area of the original ground under pavements and concrete slabs shall be excavated to remove all objectionable matter, sod, muck, rubbish and other unsuitable materials to a minimum depth of 300 mm.

#### 4. Filling and Backfilling

Fill and back fill materials shall consist of suitable materials from excavation or from approved borrow areas, and shall be free from roots, wood scraps, vegetation and other extraneous materials and from large clods of earth or stones greater than 100 mm. no fill material shall be placed until the surface to be filled has been approved.

##### (a) Filling and Backfilling for Structures and Trenches

Filling around structures shall be placed as the construction work progress, insofar practicable. Backfilling for trenches shall progress as construction and testing will permit. Back filling pipe trenches, approved backfill shall be compacted in 200 mm layers to a depth of 150 mm over the pipe and the remainder of the trench depth shall be backfilled and compacted in 300 mm layers; for trenches under road pavements and concrete floor slabs, the backfill shall be placed and compacted in 200 mm layers to the top of the trench.

##### (b) Embankment Construction

Before placing fill material, the surface upon which it will be placed shall scarify to insure good bonding between the existing surface and the fill material. Where embankment is to be constructed on sloping ground with slopes steeper than 1 vertical to 4 horizontals, the new fill shall be cut into or benched as the embankment is brought up in layers in such a manner that the embankment material will bond with the existing surface. The size of each bench shall be subject to approval and shall depend on the equipment to be used.

#### 5. Equipment

Equipment used in the performance of the work shall be subject to approval of the project manager. The quality of compaction equipment shall be adequate to assure thorough uniform compaction as rapidly as material is placed. In all areas not accessible to rollers or compactors the fill shall be compacted with mechanical hand tampers.

#### 6. Compaction

In fill areas, the top 200mm shall be compacted to a density of at least 95 percent of maximum density and the remaining depth of fill to not less than 90 percent of maximum density, except that under ramps pavement and concrete floor slabs, compaction shall not be less than 85 percent of the maximum density for the entire depth of fill. Unless otherwise indicated where the existing sub-grade in cuts have a density of less than 95 percent, all materials to a depth of 150mm or to such greater depth as maybe specified, shall be compacted not less than 95 percent of the maximum density. Soil moisture during compacting shall be



controlled between 80 and 110 percent of optimum moisture content determined in accordance with AASHTO Method T99-84.

#### 7. Disposal of Surplus Excavation Materials

Any surplus material from the excavation and grading operation shall be disposed and spread in soil areas designated by Project Manager except for the materials classed as rubbish and debris, which shall be deposited in the spoil areas shall be graded to a reasonably uniform surface.

#### 2.4.3 Septic Tank

The contractor shall construct septic tanks. Placenta pits and vaults in accordance with the size and dimension shown on the detailed plans. Septic tank shall be constructed with two chambers; the primary sedimentation chamber which serve as the digestion chamber and the final sedimentation chamber, which receives the overflow from the digestion chamber. The effluent from the final sedimentation shall be discharge whenever practicable to the surface waste water infiltration system. In some cases, or as shown on the drawings, the final sedimentation chamber will be designated to leaching chamber i.e., with final open bottoms/flooring with gravel for leaching.

#### 2.4.4 Placenta Pit/Vault

The contractor shall construct placenta pit and vault for sharp object in accordance with the size and dimension shown on the detailed plans. It shall be constructed with one chamber with proper cover and screen. The finish of the top floor shall be higher by 200mm from the highest flood level in the area. The floor and walls shall be water tight.

#### 2.5 Method of Measurement and Basis of Payment

Measurements of accomplished quantities shall be of the ff. methods:

(1) Lump sum payment shall be provided for the following:

a. Site demolition and clearing shall be deemed to include the cost of salvaging the materials, preservation, storage and disposal.

b. Construction of septic tank, placenta pit and septic vault for sharp objects holding and water storage tank (including reservoir and piping) shall be considered to include the cost of excavation and backfilling, bedding, forms and false work curing fasteners and incidentals to complete each item of work.

c. Subsurface waste water infiltration system shall be deemed to include the cost of excavation, disposal, gravel filter, silt barrier, overflow and distribution pipes and incidental works to complete this item.

(2) The volume of the structural excavation to be paid shall be the number of cubic meters measured in original position of material acceptably excavated in conformity with the plans or as directed by the payment of quantities accomplished shall be deemed to include the cost of disposal of excess and unsuitable materials, shoring, bracing, water control work and other operations necessary to complete the item.

(3) The volume of backfill materials from excavation; fill materials from common borrow; top soiling; construction of embankment; sub-base and base course preparation; and compacted fill bedding to be paid for shall be the number of cubic meters measured in the final position of materials actually provided and installed to include where applicable, furnishing, placing, spreading and compaction in accordance with the plans and specifications and disposal of excess and suitable materials, if any.

(4) The work item for soil treatment is as stipulated in Sub-Section 2. Soil poisoning shall be measured and paid for per square meter area of works accomplished and accepted. Payment of work accomplished shall be made based on dimension shown in the drawings and stipulated in the specifications.

The quantities measure as provided above shall be paid for at the contract unit price for each of the paid item, which price and payment shall be full compensation for furnishing and placing all materials, labor, equipment, tools, and incidentals necessary to complete the work.

### 3.0 CONCRETE

#### 3.1 Scope of work

The work includes construction of concrete structures complete in accordance with the standard specifications and conformity with the lines, grades, thickness and typical cross-section shown on the plan.

#### 3.2 Reference Standards

The latest edition of the following standards shall be from a part of this specification:

|        |  |
|--------|--|
| ACI    | American Concrete Institute  |
| 211-01 | Standard Practice for Selecting proportions for Normal and Heavyweight Concrete          |
| 301    | Concrete, Structural for Building  |
| 309R   | Standard Practice for Consolidation of Concrete  |
| 318    | Building Code Requirements for Reinforce Concrete  |
| AASHTO | American Association of State Highway and Transport Officials                            |
| M173   | Concrete Joint Sealer, Hot-Poured Elastic Type Performed Expansion Joint Filler Concrete |
| ASTM   | American Society for Testing Materials   |
| C33    | Concrete Aggregates  |
| C31    | Standard Practice for Making, Curing Concrete test Specimen in the Field                 |
| C39    | Comprehensive Strength of Cylindrical Concrete Specimen                                  |
| C42    | Obtaining and Testing Drilled Cores and Sawed Beams of Concrete                          |
| C94    | Standard Specification for Ready-Mixed Concrete  |
| C143   | Standard Test Method for slump of Portland Cement Concrete                               |
| C150   | Portland cement, Specification for   |
| C309   | Liquid Membrane-Forming Compounds for Curing Concrete                                    |

DPWH Blue Book Vol. III (1995)

### 3.3 Material Requirement

#### 3.3.1 General

Concrete shall be composed of Portland cement, fine and coarse aggregates, water and admixture as specified all thoroughly mixed and brought to proper consistency, uniformity and temperature for final placement.

#### 3.3.2 Cement

Concrete shall be Portland cement of a brand approved by the Project Manager and conforming to ASTM Specification C150. Type I or Type II.

#### 3.3.3 Water

Water shall be clean and free from injurious amounts of oils, acids, alkalis, salts, organic materials, or other substances that may be deleterious to concrete or steel.

#### 3.3.4 Admixtures

Admixtures shall be subject to prior approval by the Project Manager. The admixtures shall be capable of maintaining essentially the same composition and performance throughout the work.

#### 3.3.5 Fine Aggregates

Fine aggregates shall consist of natural sand, manufactured sand, or a combination thereof. If the fine aggregate shall be a combination of separately processed sizes, or if batching shall be in a combination of natural and manufactured sand, the different components shall be batched separately. Fine aggregates shall consist of hard, tough, durable, uncoated particles. The specified percentages of fines in the sand may be obtained either by the processing of natural sand or by the production of suitably graded manufactured sand. The shape of particles shall be generally rounded or cubical and reasonably free from flat or elongated pieces. The use of beach sand shall be prohibited. The fine aggregate shall conform to the following specific requirements:

| <u>Std</u> | <u>Sieve Designation</u><br><u>U.S Std., Square Mesh</u> | <u>Cumulative Percentage by</u><br><u>Weight Passing</u> |
|------------|--|--|
| 9.5 mm     | 3/8  | 100  |
| 4.75 mm    | No.4   | 95-100   |
| 2.36 mm    | No.8   | 80-100   |
| 1.18 mm    | No.16  | 45-80  |
| 300-micron | No.50  | 10-30  |
| 150-micron | No.100   | 2-10   |

In addition to the grading limits shown above, the fine aggregates, as delivered to the mixer, shall have a fineness modulus not less than 2.3 more than 3.0 and during normal operations, the grading of the fine aggregate shall be controlled so that the fineness modulus of at least nine (9) out of ten (10) test samples of fine aggregate as delivered to the mixer shall not vary by more than 0.20 from the average fineness modulus can be determined by dividing 100 the sum of the cumulative percentages retained on U. S. Standard Sieves Nos. 4,8,16,50 and 100.

### 3.3.6 Coarse Aggregates

Coarse aggregate shall consist of washed gravel, crushed stone or rock, or a combination thereof conforming to ASTM C33. The coarse aggregate, as delivered to the batching plant, shall have uniform and stable moisture content. The approval of deposits shall not be construed as constituting the approval of all materials taken from the deposits, and the Contractor shall be held responsible for the specified quality of all such materials used in the work. Coarse aggregate shall consist of hard, tough, durable, clean and uncoated particles. All foreign materials and dust shall be removed adequate shall be generally rounded or cubical, and the coarse aggregate shall be reasonably free from flat and elongated particles. A thin, flat and elongated particle can be as defined as a particle having a maximum dimension greater than five times the

minimum dimension. The coarse aggregate shall be graded from fine too coarse. It shall be separated into size groups.

The grading of the aggregate within the separated size groups as delivered to the mixer shall be as follows:

| Sieve Sizes | Percent by Weight |        | Passing Individual 1-1 ½ |
|-------------|-------------------|--------|--------------------------|
| Std (MM)    | US Std., Sq. Mes  | ¾ Size | Size                     |
| 50          | 2"                |        | 100                      |
| 37.5        | 1-1/2"            |        | 90-100                   |
| 25          | 1"                | 100    | 20-55                    |
| 19          | ¾"                | 90-100 | 0-15                     |
| 9.5         | 3/8"              | 20-55  | 0-5                      |
| 4.75        | No. 4             | 0-10   |                          |

Use 19 mm (3/4") coarse aggregate for slab on grade, columns, beams, suspended slabs and tie beams.

Use 38 mm (1 ½") coarse for footings.

### 3.3.7 Reinforcing Steel

Reinforcing steel shall be locally manufactured, deformed billet steel bars conforming to Philippine Standard, Grade 275, Intermediate grade (40,000 psi).

### 3.3.8 Forms

Concrete wall shall be wood, plywood, steel or other suitable materials. Form surfaces requiring standard or special finish shall be plywood or a non-absorptive hand pressed fiberboard or other suitable materials. Plywood shall not be less than 12 mm thick and shall be free from irregularities, dents and sags. Forms shall be coated with non-staining form coating compound such as form oil of the approved make.

### 3.3.9 Storage of Materials

### (1) Cement

Cement in bags shall be stored in a suitable weatherproof structure as airtight as practicable. Floors shall be elevated above the ground, sufficient to prevent the absorption of moisture. Bags shall be stocked close together to reduce circulation of air cut but shall not be shocked against outside walls. The manner of storage shall permit easy access for inspection and identification of each shipment. Cement that has been stored for so long that there may be doubt of its quality shall be tested by standard mortar tests to determine its suitability for use, and shall not be used without approval of the Project Manager.

### (2) Aggregates

Aggregate shall be stored in such a manner as to void the inclusion of foreign materials. Aggregates of different sizes shall be stored in separate plies. Stockpiles of coarse aggregate shall be built in horizontal layers not exceeding 1200 mm in depth to avoid segregation. Should the coarse aggregate become requirements here on before. Sufficient stockpiles shall be maintained at all times to permit continuous placement of concrete at the rate specified.

### (3) Reinforcing Steel

Reinforcing steel shall be stored in a manner to avoid excessive rusting or being coated with grease, oil, dirt and other objectionable materials.

## 3.4 Construction Requirements

### 3.4.1 Concrete Proportion

The proportion of all materials in a concrete shall be subject to the approval of the Project Manager. The Contractor shall employ at his own expense an approved testing laboratory, which shall design the mix proportions in accordance with ACI 211.01. Strength requirements shall be 20.7 Mpa (3000 psi) for footing, columns, beams, slabs, and stairs lavatory counter, wash basin; 17.2 Mpa (2000 psi) for lean concrete or as required by the Project Manager. The adequacy of this test shall be verified by a test on a minimum of 6 cylinders; 3 tested at 7 days, 3 at 38 days, in accordance with ASTM C39.

If, at any time during construction, the concrete resulting from the approved mix design proves the unsatisfactory for any reason such as too much water, lack of sufficient plasticity to prevent segregation, honeycomb, etc. or insufficient strength, the Contractor shall notify the testing, laboratory and the Project Manager. The laboratory shall modify the design, subject to the approval of the Project Manager until satisfactory concrete is obtained.

### 3.4.2 Concrete Samples and Testing

Sampling and testing of concrete shall be done by and at the expense of the Contractor. Throughout the period that the concrete is being poured into cylinder shall be taken from fresh concrete from the forms.

The rests shall be made for each 10 cu. M. of concrete or fraction thereof for each portion of structure as may required by the Project Manager as follows:

#### 1. Compression Tests:

At least two (2) sets of samples consisting of three (3) concrete cylinder specimens per set shall be made. Fresh concrete shall be placed inside standard 150 x 300 mm cylindrical mould in three (3) separate equal layers and rodded separately with 25 strokes with a 16 mm diameter. Surface shall be leveled with trowel and samples are to be labeled to identify the class, strength of concrete, date taken and part of structure samples are taken. The samples shall be cured in accordance with ASTM C31.

One set of cylinders shall be tested at the age of seven (7) days, and one set at the age of twenty-eight (28) days, in accordance with ASTM C39. Additional cylinder samples may be molded in reserve for further tests, if the results of the twenty-eight (28)-day-test do not meet the requirements.

#### 2. Slump Tests

Slump test shall be performed to determine the consistency or workable fluidity of freshly mixed concrete in the field. At least two slump tests shall be made and the sample of concrete from which the test specimens are made shall be



representative of the entire batch and shall conform to the procedures are specified in ASTM C143.

Freshly mixed concrete shall be placed in the slump cone 100 x 200 mm x 300 mm in three (3) equal layers. Each layer shall be rodded with 25 strokes of the 16 mm diameter tamping rod with the tamping end rounded to a hemispherical tip of the same diameter. The mould shall be leveled and lifted at once and then measure the slump action immediately by getting the difference in height between the height of the mould and the top of the slumped concrete.

The slump tests shall be performed to determine the consistency or workable fluidity of freshly mixed concrete in the field. At least two slump tests shall be made and the sample of concrete from which test specimens are made shall be representative of the entire batch and shall conform to the procedures are specified in ASTM C143.

The slump for vibrated concrete shall be 50 mm minimum and 100 mm maximum, provided that the required strength of concrete is obtained.

### 3. Test Reports

The testing laboratory shall submit four (4) copies of its cylinder which are to include as far as applicable, the following items: Location of pour in the structure, concrete design mix number, concrete design strength, type and manufacturer of cement, amount of any admixture used, slump tests, date of sampling, cylinder application number, days cured in the field, days cured in the laboratory, age and time of testing, crushing stress, type of failure, who made the samples, who shipped the samples to the laboratory and whether concrete strength meets the specifications.

### 4. Additional Tests

If, in the opinion of the project Manager, based on the cylinder reports concrete with strengths below specification requirements has been placed, the Project Manager, at the expense of the contractor test on cored cylinder, ASTM C42, and/or load tests as outlined in ACT 318 sec. 202.

#### 3.4.3 Mixing Concrete

Mixing shall be thoroughly mixer of an approved size and type to insure a uniform distribution of the materials throughout the mass:

1. Site Mixed Concrete

All structural concrete shall be machine-mixed for at least 1 ½ minutes after all materials including water are in the mixing drum. The time elapse between the introduction of the mixing of water to the cement and aggregate and placing of the concrete in final position shall not exceed 45 minutes. Placing of the material in the mixer shall be done in such a way that the first batch of concrete materials in the mixer shall contain sufficient excess cement, sand and water to coat the inside of the drum without reducing of concrete, placing additional cement, aggregate or water during mixing period shall not be permitted.

No hand mixing shall be allowed, except in case of emergency of breakdown during pouring operations, subject to the approval of the Project Manager.

2. Ready-Mixed Concrete

Ready-mixed concrete, when shall be batched, mixed and delivered from a plant approved by the Project Manager, and shall be in strict compliance with the requirements set forth in ASTM C94.

The rate of delivery of the mixed concrete shall be such that the interval between placing of successive batches shall not exceed thirty (30) minutes. The elapsed time between the introduction of mixing water to the cement and aggregate, and completion of discharge shall not exceed one (1) hour, or not more than 1 ½ hours if retarder is used. It should be kept constantly agitated during the transit period. Delivery tickets shall contain data on the weight of sand, gravel and amount of cement and water added. The Contractor shall keep legible copies available for examination of the Project Manager.

Re tempering of concrete shall not be permitted. The Contractor shall mix only quantities required for immediate use and mixture, which has developed setting, shall not be used. Concrete, which has partially hardened, shall not be tempered.

3.4.4 Concrete Placing

Concrete shall be placed only after all form works, materials to be embedded, and preparation of surface involved in the placing have been inspected and approved by the Project Manager. The Contractor shall provide equipment and shall provide equipment and shall employ methods that will minimize separation of aggregates from the concrete mix.

Water shall be removed from excavation before concrete is deposited. Flow of water shall be diverted through proper side drains to a pump, or removed by other approved methods to avoid washing over freshly deposited concrete. Hardened concrete, debris and foreign materials shall be removed from the interior of forms and from inner surfaces of mixing and conveying equipment. Reinforcement shall be secured in position, inspected and approved before pouring concrete. Runaways shall not be provided for wheeled concrete-handling equipment's, such equipment shall not be wheeled over reinforcement nor shall runaways be supported by reinforcements.

Concrete shall be handled from the mixer to the place of final deposits as rapidly as practicable by methods, which shall prevent segregation or loss of the ingredients. It shall be deposited in the forms in approximately layers and as nearly as practicable in its final position to avoid re- handling.

Conveying or handling of concrete by use of inclined chutes or pipes of more than three (3) meters shall not be permitted. Dumping of concreted into buggies, buckets or wheel borrows with a free fall of more than one (1) meter shall not be permitted. When placing operations would involve dropping of concrete more than 1 ½ meters, it shall be deposited through a sheet metal or other approved conveyor. AS for practicable, the conveyor shall be kept full of concrete during placing and their lower ends shall be kept buried in the newly placed concrete. After the initial set of concrete, the forms shall not be- jarred and no strain shall be placed on the ends of the reinforcing bars, which are being projected.

Concrete in columns shall be placed in one continuous operation. Concrete in girders, beams and slab in superstructures shall be poured in a monolithic and continuous manner. No construction joint shall be allowed on any part of the structure without the approval of the Project Manner.

Consolidated all concrete in accordance with provision of ACI 309R. Consolidate each layer of concrete greater than 4 inches in depth with high frequency, interval; mechanical equipment supplemented by hand spading and tamping. Consolidate concrete slab 4 inches or less in depth by wood tampers, spading and settling with a heave leveling straight edge. Operate vibrators with vibratory element approximately 18 inches apart. Penetrate the previously place

lift with the vibrators when more than one lift is required. Place concrete in 180-inch maximum vertical lifts. Limit duration of vibration to time necessary to produce satisfactory consolidation without causing segregation of aggregates. Provide adequate number of units and power sources at all times. Maintain spare units on hand to ensure adequacy. If in the opinion of the Project Manager the equipment being used is not adequate to accomplish proper consolidation, the Project Manager may order delay in further placement of concrete until such equipment is available for use at the location of placement of concrete.

#### 3.4.5 Protecting and Curing

##### 1. General

Concrete surfaces exposed to condition causing premature drying shall be protected as soon as possible with canvas, straw, burlap and or other satisfactory material and keep moist; or if the surfaces are not covered by shall be keep moist flushing or sprinkling, as directed by the Project Manager. All concrete shall be moist cured for a period of not less than seven (7) consecutive days after placing by an approved method or combination of method applicable to local condition.

##### 2. Moist cutting

The surface of the concrete shall be kept continuously wet water for a period of seven (7) days, by spraying or covering with burlap or other approved material thoroughly saturated with water and keeping the covering wet by spraying or intermittent hosing. Water for curing shall be generally lean and free from any element, which might cause objectionable staining or discoloration of the concrete.

#### 3.4.6 Repairs to the concrete

All imperfections on concrete surfaces and corrected to produce concrete surfaces that conform to the requirements of this section. Unless otherwise approve by the Project Manager, patching with the cement mortar shall repair imperfection on form surfaces. Cement mortar for patching shall be the same composition as used in the concrete, except for exposed surfaces; part of the cement shall be white cement to provide a finish color matching the surrounding concrete. Honeycomb or otherwise detective areas shall be cut out from solid concrete to a depth of not less than 25mm. the edges of the cut shall be perpendicular to the surface of the concrete. The area to be patched, at least 15 mm adjacent thereto shall be saturated with water before placing the mortar. The mortar shall be mixed approximately one (1) hour before placing and shall be remixed occasionally during this period with trowel without adding water. A grout of cement and water, mixed to a consistency of paint, shall then be brushed onto the surface to the mortar is to be bonded. The mortal shall be compacted into placed and screened slightly higher than the surrounding surface. Patches on exposed surfaces shall utilize plywood forms. After the removal of forms,

shall not be plastered, unless otherwise directed by the Project Manager. All joint marks on the formwork shall be reworked to a smooth surface to match adjustment areas and to present a new appearance.

### 3.4.7 Forms

#### (1) General

Forms shall be used whenever necessary to confine the concrete and shape it to the required lines and dimensions, or to protect the concrete from contamination. Forms shall have sufficient strength to withstand the pressure resulting from the placement and vibration of the concrete, and shall be maintained rigidly in correct position. Forms shall be sufficiently tight to prevent loss of mortar from the concrete. Forms for exposed surface shall be lined with form grade plywood. Bolts and rods used for interval ties shall be so arranged that when the forms are removed, they shall not be less than two (2) centimeters from the form surface.

Removal of forms or shoring is subject to approval by the engineer, and under no circumstances shall bottom form and shoring be removed until after the members have acquired sufficient strength to support their weight and the load thereon. Forms shall remain in place for a minimum time as follows:

Columns, sides of beam, shear and bearing walls ----- 3 days

Beams ----- 14 days

Reshore immediately after stripping beams and girders that support subsequent formwork.

#### (2) Cleaning and Oiling Forms

Before placing concrete, the contact surface of the forms shall be cleaned of incrustation of mortar, grout or other foreign material. Forms shall be coated with standard form oil that can effectively prevent sticking and will not stain the concrete surface.

#### (3) Removal of Forms

Forms shall be removed in a manner, which shall prevent damage to concrete structures. Forms shall not be removed without prior approval of the Project Manager. Any repair of the surface imperfections shall be performed at once and curing shall be started as soon as the surface is sufficiently hard to permit it without further damage. The minimum time period for removal of forms shall govern where it exceeds the minimum

specified curing period. Where the formwork for one element supports the formwork for another element, the greater time period shall apply to both elements. Forms shall not be removed before the expiration of the minimum time specified below:

| Element  | Time Period                  |                             |
|--|------------------------------|-----------------------------|
| Walls columns, sides of beam and girders, and slab on grade                                | 1                            |                             |
| Pan joist forms (side only): 76 cm (30 inches) Wide or less over<br>76 cm (30 inches) wide | 3                            |                             |
| Where design live:   | less than the<br>Dead loaded | greater than<br>Dead Loaded |
| Joist, beam or girder, soffits:<br>(Clear span between structural support)                 |                              |                             |
| Under 3.00 m (10 ft.)  | 7                            | 4                           |
| 3.00 m (10 ft.) to 6.00 m (20 ft.)   | 14                           | 7                           |
| Over 6.00 m (20 ft.)   | 21                           | 14                          |
| One-way floor slabs: Clear span<br>Between structural supports)                            |                              |                             |
| Under 3.00 m (10ft.)   | 4                            | 4                           |
| 3.00 (10 ft.) to 6.00 m (20 ft.)   | 7                            | 4                           |
| Over 6.00 m (20 ft.)   | 10                           | 7                           |

Sufficient shoring members to support dead loads including construction loads on beams and slab shall be provided from a period of eight (8) days in addition to the seven (7) specified thereto. The time for removal of forms for structures not included thereto shall be as directed by the Project Manager. Concrete work shall be protected from damage during construction.

### 3.4.8 Reinforcing Steel

#### (1) General

Steel reinforcement, shall be provide together with all the necessary wire tie chair, spacers, support and other necessary devices.

#### (2) Cutting and Bending

Reinforcing steel shall be accurately cut and bent in accordance with the approval detail reinforcement drawings. Reinforcing steel shall not be straightened or re-bend in a manner that will injure the material. Bars with kink or with bends not shown on the approved detail reinforcing drawing or with cracks or split of the bends shall not be used. All the bars shall be bent cold. If

contractor elects to have reinforcing steel cut and bent off the site, he shall provide, maintain and operate a small cutting and bending shop on the site and maintain a representative stock of steel. This provision is to take care of minor revisions and additions in an expeditious manner.

The Project Manager may require the contractor to prepare and submit bar cutting schedule prior to fabrication of reinforcing steel bars

(3) Placing Reinforcement

Reinforcing steel shall be accurately placed in accordance with approved detailed reinforcement drawings and shall be adequately secured against displacement by using specified tie wires or approved clips at all intersections. After it has been installed, reinforcing steel shall be inspected by the Project Manager for compliance with requirements as to size, shape, length, splicing, position and number. Reinforcing steel shall be supported by concrete or metal support, spacers or metal hangers, except for surfaces exposed to the ground or to the weather, where supports shall be concrete. Wooden support spreaders shall not be used. At surfaces where attractive appearance is required, the support shall be of the type, which shall not cause subsequent staining or marring of the exposed surface.

3.4.9 Joints in Concrete

(1) Construction Joints

Construction joints shall be provided where indicated in the drawing or as directed by the Project Manager. Joints not indicated on the drawings shall be constructed and located so as not to impair the strength of structures. When a construction joint is to be made, the surface of the hardened concrete shall be thoroughly cleaned and all laitance removed. In addition, the joint shall be thoroughly wetted and sloshed with a coat of neat cement grout immediately prior to placing of new concrete.

(2) Expansion and Contraction Joint

Expansion and contraction joints shall be provided where indicated and shall be in accordance with details.

(3) Preformed Strips

Preformed strips shall be placed before the adjoining concrete is poured. The joint sealer shall be applied after concrete on both sides of the joint has been poured and after the joint lines have been trueed

### 3.5 Methods of Measurement and Basis of Payment

The Project Manager shall be in accordance with the dimension in the plan or as otherwise direct the measurement of completed work. The quantities to be paid for under this section shall be measured as follows:

- a. The volume to be paid for under this item shall be the number of cubic meters of concrete placed and accepted. Payment for concrete shall be constructed to include the cost of forms, false works, curing, fasteners and accessories necessary to complete this item of work.
- b. The quantities for reinforcing steel to be paid for shall be the final quantity placed and accepted in the completed structure. No measurement for payment shall be made for splices added by the Contractor for his convenience. Payment for the accepted quantities for reinforcing steel shall be deemed to include the cost tie wires, separator, wire, supports, hangers, chair and other materials necessary to complete the work.

The quantities measured as provided above shall be paid for at the contract price for each of the pay item, which price and payment shall be full compensation for furnishing and placing material, labor, equipment, tools and incidentals necessary to complete the work.

## 4.0 MASONRY

### 4.1 Scope of Work

The work includes furnishing and placing of concrete masonry, units of conformity with the lines, grades and cross-sections shown in the drawings and in accordance with the specification.

### 4.2 Applicable Documents

The latest edition of the following specification and standards shall form part of this specification to the extent required by the references thereto.

|        |   |
|--------|---|
| ASTM   | America society for testing materials                   |
| C144   | standard specification for aggregate for masonry mortar |
| PSA    | Product Standards Agency Publication (Philippines)      |
| PNS 16 | Specification of Concrete Hollow Blocks                 |



### 4.3 Material requirement

#### 4.3.1 Concrete Hollow Blocks

Concrete hollow blocks shall be standard product of recognized manufacturer to PNS 16, as indicated on the drawings. Exterior and interior masonry units shall be non-load bearing units. For non-load bearing units, the required compressive strength shall be 25 kg/cm<sup>2</sup> or 2.48 Mpa.

#### 4.3.2 Cement, Reinforcing Steel and Water

Cement, reinforcing steel and water shall be as specified in section 3.0

### 4.4 Construction requirements

#### 4.4.1 Workmanship

Masonry walls shall be placed level and plumb all around. One section of the walls shall not be placed in advance of the others, unless specifically approved: unfinished work shall be stepped back for joining with the new work; tooting shall not be permitted. Heights of masonry work shall be checked with an

Instrument at sills and heads for openings, to maintain the level of the walls. Door and window frames, louvered opening, anchors, pipes and conduits shall be installed carefully and neatly as masonry work progresses. Spaces around door frames shall be filled solidly with mortar. Drilling, cutting, fitting and patching to accommodate the work of others, shall be performed by skilled workers. Bolts, anchors, inserts, plugs, ties and miscellaneous metal work specified elsewhere shall be placed in position as the work progresses. Chases of approved dimensions for pipes and other purposes shall be provided, where indicated or necessary. Top of exposed walls and partitions, not being worked on, shall be covered with a waterproof membrane, well secured in place. Wall and partitions shall be structurally bonded or anchored to each and to concrete wall beams, and columns.

#### 4.4.2 Mortar Mixing

Mortar material shall be measured in approved container to ensure that the specified proportion of materials are controlled and accurately maintained during the progress of the work. Unless specified otherwise, mortar shall be mixed in such a manner that the materials will be disturbed uniformly throughout the mass. A sufficient amount of water shall be added gradually and the mass further mixed not less than 3 minutes, until the mortar of a plasticity required for the purpose intended shall be obtained. The mortar shall be mixed in a manner such that the quality of water can be controlled accurately and uniformly. Mortar boxes, pans of mixing drums shall be kept clean and free

from debris or dried mortar. The mortar shall be used before the initial setting of the cement has taken place; retempering of mortar in which cement has started set shall not be permitted.

#### 4.4.3 Proportion of mortar Grout

Fine grout shall be used in grout spaces less than 50 mm in a horizontal dimension or when clearance between reinforcement and masonry is more than 17mm.

#### 4.4.4 Use of Fine and Coarse Grout

Fine grout shall be use in grout spaces less than 50 mm in my horizontal dimension or when clearance between reinforcement and masonry id more than 17 mm.

#### 4.4.5 Mortar Joints

Mortar joints shall be uniform in thickness and be average thickness of any three consecutive joints shall be 9.50 mm “gage rods” shall be made and approve prior to starting the work and shall be used throughout the work. Changes in coursing or bonding after the work has started shall not be permitted. The jointer shall be slightly larger than the width of the joints so that complete contact is made along the edge of the units, compressing and sealing the surface of the joint. Joints in masonry, which will not be exposed, shall be stuck flush. Joints shall be brushed to remove all loose and excess mortar. All horizontal joints shall be on level and vertical joints shall be plumbed and aligned along the top to the bottom of the wall with a tolerance of plus or minus 12mm.

#### 4.4.6 Concrete Masonry Unit

The first course of concrete masonry unit shall be laid in full bad of mortar, for the full width of the unit; the succeeding courses shall be laid with broken joints. Concrete masonry units with the cells vertical shall have bed-joints formed by applying the mortar to the entire top of the surface of the inner or outer face shall, and the head joints formed by applying mortar of a width about 25mm to the edge of the adjoining units lay previously the mortar for joints shall be smooth, not furrowed, and shall be of such thickness that it will be forced out of joints as the units are being placed in position. Where anchors, bolts, ties, and reinforcing bars occur within the cell of the units, such cells shall be solidly filled with mortar or grout as the work progress.

#### 4.4.7 Reinforcement

Horizontal ties reinforcement shall be provided where indicated. Reinforcement shall be continuous and provided in the longest available lengths. Reinforcement above and below openings shall extend and be embedded into

the columns, unless otherwise shown on the drawings. Spices shall overlap not less than 150 mm. Reinforcement shall be embedded in the mortar joints in the manner that all parts shall be protected by mortar. The two top courses of filler block walls shall have their cores filled with grout when placed in position.

Unless otherwise shown on the drawings, the size and spacing of bars shall be as follows:

For Vertical Bars:

150 mm (6") CHB - 12 mm (1/2") dia. At 600 mm  
(24") on centers

100 mm (4") CHB - 10 mm (3/8") dia. At 600 mm

For Horizontal Bars: - 12 mm (1/2") dia. At 600 mm  
(24") on center (every third Course)  
for 150 mm  
(6") and 100 m (4") CHBs.

#### 4.4.8 Bounding and Anchoring

Masonry walls and partitions shall be accurately anchored or bonded at points where they intersect, and where they abut or adjoin the concrete frame of the building. All anchors shall be completely embedded in mortar.

#### 4.4.9 Grout Placement

Grout shall be performed on the interior side of wall, except as approved otherwise, sills, ledges, offsets and other surfaces to be left exposed shall be protected from grout falling on such surfaces and be and shall be removed immediately. Grout shall be stirred before placing to avoid segregation of the aggregate and shall be sufficiently fluid to flow into joints and around the reinforcement without leaving any voids. Grout shall be placed by pumping or pouring from buckets equipped with spouts, in lifts not exceeding 1.2 meters high. Grout shall be puddle thoroughly to eliminate voids without displacing the masonry units from its original position. Masonry units displaced by grouting operation shall be removed and re-laid to its proper alignment using fresh mortar grout.

#### 4.4.10 Tests and Test Reports

The testing requirement stated herein or incorporated in referenced contract documents may be waived provide certified copies of report of tests from approved laboratories performed on previously manufactured materials are

submitted and approved. Test reports shall be accompanied by notarized copies from the manufacturer certifying that the previously tested material is of the same type, quality manufacturer, and make those

#### 4.5 Method of Measurement and Basis Payment

In measuring the quantity of masonry units for payment, the dimensions to be used shall be as shown on the plans or as directed by the Project Manager in writing. Projections extended beyond the faces of the wall shall not be included. The area to be paid for in this section shall be the number of square meters of concrete masonry wall and partition placed and accepted in accordance with the plans and specifications. Payment of accomplished work shall be deemed to include the cost mortar grout, reinforcing steel, tie wires, false work and other necessary works to complete this item.

The quantity of concrete masonry walls and partition shall be paid for at the contract unit price shown in the bid schedule, which payment shall be full compensation for furnishing and placing all materials, labor, equipment, tools and incidentals necessary to complete the work.

### 5.0 METALS

#### 5.1 Scope of work

The work includes the furnishing, fabrication, erection or installation of structural steel roof framing, Stainless Handrails and miscellaneous metal work in accordance with this specification and as shown in the drawings.

#### 5.2 Applicable Specification and Standard

The latest edition of the following specifications and standards referred to herein after by basic designation only, shall form part of the specification:

|          |  |
|----------|--|
| ASTM     | American Society for Testing and Materials                   |
| A36/A36M | Specification for Structural Steel                           |
| A53      | Steel Pipe Zinc Coated Welded and Seamless Black and Hot-Dip |
| A307     | Bolts and Studs, 60, 000 psi Tensile Strength                |
| A325     | Standard Specification, high Strength Bolts for joints       |
| A570     | Hot-rolled Carbon Steel Sheet and Strip, Structural Quality  |
| A611     | Steel, Cold-Rolled Steel, Carbon, Structural Quality         |

|      |  |
|------|--|
| AWS  | American Welding Society   |
| D1.1 | Structural Welding Code, Steel   |
| AISC | American Institute of Steel Construction, Specification for the Design, Fabrication, Erection of Structural Steel for Buildings. |
| AISI | American Iron Steel Institute, Specification for the Design of Light Gage Cold-Formed Steel Structural Members                   |

### 5.3 Material Requirement

#### 5.3.1 Structural Steel Shapes Plates and Bars

Unless otherwise shown or specified on the drawing, structural steel shapes plates and bars shall conform to ASTM specification A36/A6M.

#### 5.3.2 Hot-Formed Steel Sheet and Strip

Unless otherwise shown or specified on the drawing, hot-formed steel and strip shall conform to ASTM A570.

#### 5.3.3 Bolts, Nuts and Washer

It shall conform to specification STM A370, with a minimum yield point of 33,000 psi, unless otherwise shown in the drawings. Heavy hexagonal structural bolts, heavy hexagonal nuts and hardened washers, shall be quenched and tarpapered medium-carbon steel bolts, nuts and washers complying with ASTM A325.

#### 5.3.4 Screw and Expansion Bolts

Screw and Expansion bolts be of standard commercial grade, and of the sizes and types indicated as approved by the

#### 5.3.5 Electrodes

Electrodes for are welding shall be E60, or E70, AWS D1.1.

#### 5.3.6 Galvanizing

Unless otherwise specified, galvanizing shall be of standard quality, hot-dipped process of 1.25 ounce per square foot of coating. Galvanized surface that are damage prior to final acceptance shall be repaired using and approved repair compound to the satisfaction of the Project Manager.

#### 5.3.7 Railings/Handrails

3” dia stainless steel pipe shall be used for hand rails and vertical railings properly installed as indicated in the plans. Joints and surfaces that are damaged prior to final acceptance shall be repaired using an approved repair compound to the satisfaction of the Project Manager.

#### 5.3.8 Miscellaneous Metals

Miscellaneous metals including fastenings, anchorages and incidentals not specifically mentioned herein or in other sections of these specifications but are required to complete the work, for which there are no detailed drawings, shall be provided and installed in accordance with standard practice of the trades as approved by the Project Manager.

#### 5.3.9 Delivery, Storage and Handling

Fabricated materials delivered to job site shall be stored in clean and protected dry areas in manufacturer’s protective package. Structural steel materials to be stored shall be skids above the ground. It shall be kept clean and properly drained. Skids placed near enough together to prevent injury from deflection shall support long members, such as purlins and chords. The Contractor shall check the quantity and quality of materials turned over to him against the delivery list and report promptly in writing any shortage or damage discovered.

### 5.4 Construction Requirements

#### 5.4.1 General

Fabrication and erection of structural steel shall be in accordance with AISC specification for the design. Fabrication and erection of structural steel for buildings except as specified herein. The Contractor shall submit to the Project Manager for approval shop drawings showing the proposed method of fabrication and installation of all metal work. No work shall be started until the shop drawings have been approved. And all work shall conform to the approved shop drawings.

#### 5.4.2 Fabrication of Steel Structure

The work shall be well formed at the shape and size shown and assembled as detailed. Structural members shall be fabricated and assembled in the shop to the greatest extent as possible. Shearing and punching shall be produced in clean, true lines and surfaces with burrs removed. Nuts shall be drawn up to tight. Joints, which are to be exposed to the weather, shall be weather lights. Holes shall be cut, drilled or punched at right angles to the surface of the metal and

shall not burning enlarge made ort. Holes in base or bearing plates shall be drilled.

#### 1. Welding

Structural steel shall be welded in accordance with the standard code of Arc and Gas Welding in Building Construction of the American Welding Society. Qualified welders shall perform all welding work only.

#### 2. Shop Painting

Unless otherwise specified or indicated in the drawings, all structural steel work (except galvanized surfaced and surfaces that will be painted with epoxy) shall be given a shop coat of red lead or zinc chromate primer.

### 5.4.3 Erection

The steel structure shall be erected true to line and grades. Bracings and support shall be introduced whenever necessary to take care of all the loads to which the structure may be subjected. Such bracings shall be left in place as long as may be required for safety. As erection progress, the work shall be securely bolted to take care of all the dead loads, wind and erection stresses. No reaming of undersize bolt holes shall be permitted, and erection bolts shall not be permitted, and erection bolts shall not be used for lining up members.

#### 1. Drift Pins

Drift pins may be used only to bring together several parts; they shall not be used in such a manner as to direct to distort or damage the metal.

#### 2. Gas Cutting

The use of gas cutting torch in the fields for correcting fabrication errors shall not be permitted on any major member in the structural framing. It's used may be permitted only when the member is not under stress, and subject to the approval of the Project Manager.

#### 3. Base Plates and Bearing Plates

Base plates and large bearing plates shall be supported in steel wedges or shims until the supported members have been plumbed, following which the entire bearing are shall be grouted with no-shrink cement grout.

#### 4. Grouting Mortar for Setting Base Plates

Concrete grout shall be a non-shrinking type grouting mortar. The mortar subject to the approval by the Project Manager can either be a mixture of

Portland cement, well graded fine aggregate, aluminum powder, and water or an approved commercial grouting mortar containing non-metallic chemical oxidizing agent. If adopted, the approved product shall be delivered to the site of the work in original sealed container bearing the trade name of the manufacturer. Surfaces to receive the mortar shall be clean and shall be clean and shall be moistened thoroughly before placing the mortar. Exposed surfaces of mortar shall be water cured we burlap for at least seven (7) days.

#### 5. Setting Up

Steel shall be erected plumb, level and properly guyed. In setting or erecting structural steel, the individual piece shall be considered plumb or level where the error does not exceed 1 to 500.

#### 6. Inspection

The Contractor shall have given the Project Manager at least fifteen (15) days' notice prior to the start of work at the mill shop, so that the required inspection may be made. The term "mill" means any rolling mill shop or foundry where material for the work is to be manufactured and fabricated. No materials shall be rolled or fabricated until the said inspection has been provided.

The Contractor shall furnish the Project Manager with copies of the certificate mill reports of the structural steel structure preferably before but not later than the delivery of steel structure to the job site.

The Contractor shall furnish all facilities for inspection and the Project Manager shall be given free access to the mill or shop and premises at all times. The Contractor shall furnish without charge all labor, machinery, materials and tools necessary to prepare test specimens.

Inspection at the mill or shop is intended as a means of facilitating work and avoiding errors. It is expressly understood that it will not relieve the Contractor from any responsibility for imperfect materials or workmanship and the necessity for replacing the same. The acceptance of any materials or furnished member at the mill or shop by the project manager shall be preclude their subsequent rejection if found defective before final acceptance of the work. Inspection of welding works will be in accordance with the provision of the section 5 of the "Standard Code of Arc and Gas Welding and building Construction of the American Welding Society.

#### 5.5 Method of Measurement and Basis of Payment

1. The quantity of the structural roof framing to be paid for shall be the number of kilograms completed in place and accepted payment for the accepted quantities shall be deemed to include the cost of steel plates, anchor bolts,



buckles, sag rods, cross bracings, purlin mounting accessories and other works necessary to complete this work item.

2. The quantity to be paid for stair nosing and railing shall be the number of linear meters placed and accepted. Payment shall be construed to include the cost of false work, anchors and other materials used in mounting this item.

The quantity determined as provided above shall be paid for the contract price for each of the pay item listed in the bid schedule, which price and payment shall be full compensation for furnishing and placing all materials, labor, equipment, tools, and incidentals necessary to complete the work.

## **6.0 ROOFING AND MOISTURE & THERMAL PROTECTION**

### **6.1 Scope of work**

This section include the furnishing of all plant tools, equipment, materials and other in the installation of water proofing and roofing, including miscellaneous sheet metal work as required providing a waterproof installation.

### **6.2 DESCRIPTION**

The work includes installation of pre-painted Rib-type long Span roofing (0.6mm thk.) complete with hardware and accessories.

#### **6.2.1 GENERAL**

The work includes furnishing all materials and requirements and performing all operations to provide a long span corrugated twin ribbed roofing and miscellaneous roofing work as required to provide the acceptable installation. Surface to which metal formed roofing sheets are to be applied shall be thoroughly cleaned and prepared, free from any defects that may affect the application. Metal formed roofing shall be lapped and lapped and installed as applicable. Details shall be in accordance with manufacture's recommended installation practice.

Metal formed roofing and sheet and accessories shall be carefully handle at all times in strong and handling to prevent damage to the surfaces edges and ends and shall be slightly elevated for drainage.

Metal formed roofing and sheet and accessories shall be delivered to the site in the original sealed container or packages bearing the manufacturer's name and brand designated where materials are covered by a reference specification number, type and class as applicable.

### 6.3 INSTALLATION

Lay and install the first sheet with turned down edge toward the outside of the area to be covered. Overlap the next sheets to the previous sheet in such a manner that the exposed edge I turned down and the covered edge I turned up. Side up fasteners should be done by the rivets and washers spaced from 300 mm to 450 mm on centers.

Care should be exercised in the proper anchorage of all roof frames.

Ridge strips for ridge rolls and ridge flashings are attached to the roofing sheets by means of rivets. Other flashings are to be fabricated from plain sheets of the same materials as the roofing in accordance with the details and/or site requirements. These are also attached to roofing by means of rivet.

#### 6.3.1 TEMPORARY PROTECTION

Metal formed roofing sheets surfaces requiring from stains, discoloration, surface abrasion and other construction abuses shall be suitably protected in accordance with the manufacturer's recommendations.

#### 6.3.2 FINAL CLEARING

Upon completion, the Contractor shall clean the metal formed roofing sheets surfaces and drain line of burrs, leaves, stone and other foreign matter that may impair the flow of water. Surface shall be kept clean by periodic inspection.

### 6.4 RADIANT HEAT BARRIER

#### 6.4.1 SCOPE OF WORKS

The Contractor shall furnish and install all labor and materials to complete the work.

#### 6.4.2 MATERIAL

#### 6.4.3 RADIANT BARRIER

Radiant Barrier shall be fire retardant aluminum foil for roof insulation. It shall have 6 layer fire retardant double-sided aluminum foil laminated with superior radiant heat barrier properties. It shall be tear proof, waterproof and possesses the following properties.

|                          |   |
|--------------------------|---|
| Elongation               | : 150% ASTM D882  |
| Water Vapor Transmission | : Greater than 5000 Mns/g<br>ASTM E96 – E                         |
| Water Vapor Permeance    | : Less than 0.20 ng/Ns<br>Less than 0.004 (Perms)<br>ASTM E96 – E |
| Tensile Strength         | : M.D. 6.6 KN/m<br>D.D.5.0 KN/m<br>C.D.4.7 KN/m<br>ASTM 828       |
| Puncture Resistance      | : 1.0 Joules  |
| T. APPA T800             |   |
| Reflectivity             | : 86% ASTM E466 – 76  |
| Emissivity               | : 5%  |
| Roll Size                | : 1.25 m x 60 m = 75.00sq. m.                                     |
| Weight                   | : 200 g/m <sup>2</sup>  |
| Thickness                | : 0.190 mm  |
| Total R –Value (M2K/W)   | : 1.72  |
| Fire Retardant           | : Part 6 Class 0<br><br>Part 7 Class 1                            |

#### 6.4.4 WORKMANSHIP

The product shall be delivered to the site in its original package or container bearing the manufacturer's name and brand designation.

All material shall be installed by skilled and selected workmen familiar with the aforementioned product.

For further information, see manufacturer's specifications.

6.5 ELASTOMERIC WATERROOFING MEMBRANE (Roof Deck Slab, Shear Wall, Comfort Rooms and Other locations where necessary)

6.5.1 SCOPE OF WORKS

The Contractors shall furnish and install all materials and labor required to provide waterproofing on designated locations.

6.5.2 MATERIALS

Elastomeric waterproofing membrane shall be liquid applied single component and made by a reputable manufacturer.

6.5.3 PREPARATION

All surfaces to be waterproofed should be clean, sound and dry. Concrete surfaces should have light steel – trowel followed by a fine hair – broom or equivalent finish that is dry and free from dust, oil and other contaminants. Remove all high spots. Moss and lichen must be removed physically followed by treatment with fungal wash down through and allow to dry. Lattence should be removed from concrete by grit blasting, wire brushing or wet jet blasting and allowing to dry.

6.5.4 Water Testing

All waterproofed surfaces, roof, siding, gutter and downspout system shall be tested for water tightness by flushing or flooding, with water as directed by the consultant. Floodwater shall be kept on gutters, downspout for a minimum time twenty – four (24) hours. If any leak occurs, the works shall be repaired or reconstructed. Test shall be repeated until satisfactory result has been attained.

6.6 Methods of Measurement and Basis of Payment

The accepted quantities measured as prescribed in the bill of quantities shall be paid for the appropriate contract until price for the pay item listed as shown in the bid schedule, which price and payment shall be full compensation for placing all materials, labor, equipment, tools and incidentals to complete the work.

## 7.0 DOORS AND WINDOWS

### 7.1 Scope of Work

This section calls for the furnishing fabrication and installation of doors and windows in accordance with the plans and specifications.

### 7.2 Materials Requirements

#### 8.2.1 Wood Doors

##### (1) General

Door's schedule, color and design shall be in accordance with the plans. Door panels shall have 44 – mm thickness, unless otherwise specified or shown on plans, except for counter doors, which shall be 31 mm thick.

##### (2) Door Types

###### (a) Hollow Core Doors

Except as otherwise specified, flush door shall be done in accordance with the detail as shown on the plans. The plywood edge protection shall be around and into the outside frame of the door in order to prevent “peeling off” of the plywood veneers at the edges.

##### (3) Lumber

Lumber for doors shall be of commercial grade, of the approved quality of each kind, well-seasoned, thoroughly dry and free from loose or unsound knots, shakes, pitch pockets or other imperfections affecting its strength, durability or appearance .

(a) Door frames in contact with concrete shall be yakal, good grade of design size and thickness as indicated in the drawings. Application of black coal tar between contract surfaces shall be provided.

(b) Door studs, nailed and frames shall be tanguile, S4S and kiln dried with not more than fourteen percent (14%) moisture content.

##### (4) Plywood

Plywood for interior flush doors shall be tanguile, first class and of commercial standard. For toilets and baths, use marine plywood

##### (5) PVC Doors

PVC doors for interior shall be of best quality, PVC doors shall be 44 mm. thick and shall also provided with bottom louvered portions as indicated in the plans.

(6) Aluminum Glass Doors

Aluminum frame glass doors shall be provided with 6 mm thick laminated colored or tinted glass; with standard aluminum tubular section with powder coated finish, with upper transoms or fixed fan lights (also provided with 6mm thick laminated colored or tinted glass) as indicated in the plans. Also provided aluminum push bar with powder coated finish and door pivots or thin slab floor hinges. Also provide integral lock system. Details and sizes shall be accordance with the plans and supplementary drawings.

(7) Flush doors (Wooden Hollow-core Flush Doors)

Wooden Hollow-Core Flush Doors shall be 44 mm. thick. And use 6 mm thick marine plywood. Provide paint finish.

(8) Metal Flush Doors (Wooden Hollow-core Flush Doors)

Double-swing Metal Flush Doors shall be 44 mm. thick steel door with standard honeycomb insulation; with ga.20 galvanized door skin and ga.16 galvanized bended plain rabbet jamb for double-swing doors, with paint finish of epoxy enamel spray and provided with 6 mm. thick clear half or narrow lite glass panels as indicated in the plans. Also provide heavy duty door pivots or thin slab floor hinges and other required accessories such as stainless-steel door handles, standard duty deadbolt lock, and stainless-steel push plate for stretchers. Details and sizes shall be in accordance with the plans and supplementary drawings.

(9) Fire-Rated Exit Doors

Fire-rated exit doors shall be listed, provided with paint finish of epoxy enamel spray, also provided with mineral rockwool insulation (which has a 2 ½ hours fire rating). In addition, these doors shall also be provided with stainless-steel heavy-duty ball bearing hinges as well as heavy duty hardware accessories such as panic rim exit device and door closer by leading brands.

7.2.2 Glass Jalousie Windows

(1) Layer Type Operation

This type of jalousie window shall be capable of locking the unit of any position and cannot be opened outside. Louver with glass slat clips and tilt gear casing shall be extruded aluminum section, true to details with clear, straight, sharply defined profiles and green from defects impairing its strength or durability. Aluminum extruded section and strips shall be Type AA conforming to ASTM B 235-50T.

(2) Window Frames (Wood Jambs)

Opening frames for jalousie window shall be well seasoned thoroughly dried “yakal” to avoid any possibility of warping after the glass jalousie window materials has been set in place.

(3) Glass Pane

It shall be clear glass of high quality, free from unevenness or other imperfection that affects its quality and form.

7.2.3 Steel Casement Windows

All steel windows shall be product of reputable and nationally known manufacturers approved by the Construction Officer. Unless otherwise indicated, all window frames shall be constructed to withstand a minimum 1225N/sq. m. wind load with the sashes in closed position. Windows shall be design for glazing from outside with continuous glazing heads.

The Contractor shall submit to the Officer shop drawing for approval showing design, elevation of window, full sections of sash, frames and mullion, hardware, construction and assembly details. Details of anchorage, erection, proposed location and method of joining and splicing of the unit to be installed shall be clearly shown. Fabrication shall, not commence until these shop drawing have been submitted and approved.

7.2.4 MATERIALS

Window members shall be low-carbon, new hot –rolled steel frame. Vent sections shall be Zee-bars not less than 25mm in depth or 3mm in thickness for light section 32mm depth for heavy sections. All members shall be special sections hot-rolled from new billet steel. Muntins when required shall be 22mm x 32mm rolled tee sections.

7.2.5 CONSTRUCTION

Corners of the frames and vents shall be mitered and electrically welded, exposed surfaces ground smooth.

Muntins shall be attached to frame or vent members by means of mortise tenon joints and riveted.

Muntin intersections shall be of interlocking design with flush interior surfaces.

Hinges shall have bronze-to-steel contact surfaces throughout. Hinge pins shall be steel, rust proofed.

Double, full contact weathering shall be provided between vents and frames around the entire perimeter of each vent.

Windows shall be designed for glazing from the outside with angle glazing clips and steel sash putty. All units shall be prepared for and supplied with necessary standard hardware.

#### 7.2.6 HARDWARE

Hardware for doors and windows shall be acceptable foreign and local products of the types, materials, sizes and mechanism as indicated on the drawing, and shall be free from any mark or other defect. Submit samples for Construction Officer's or Architect's approval.

Hinges and door closer shall be the type size and capacity as indicated on the drawings, however item as to weight and other load of doors and windows and minor modifications may be made without change in construction cost.

Each vent shall be a solid bronze, polished, cam locking handle and strike.

#### 7.2.7 SHOP FINISH

All windows shall be given one shop coat of approved rust inhibitor of the standard type with the steel window manufacturer.

#### 7.2.8 PAINTING

Refer to the Section entitled PAINTING.

#### 7.2.9 PROTECTION AND CLEANING

The Contractor shall be responsible for protecting the windows during construction and for cleaning at the completion of the building.

#### 7.2.10 SAMPLES AND SUBMITTALS

Submit samples of panel glass not less other than 2"x3" and glazing material in lengths not less than 6" for Construction Officer's approval. Submit



manufacturer specifications and recommendations for glazing conditions specified herein. Submit certificate of compliance, certifying conformity with the requirements of this specification.

#### 7.2.11 DELIVERY

All glass shall carefully pack for transportation, exercising reasonable precaution to ensure avoidance of damage during transmit. Care shall be insured in unloading, unpacking and storage on arrival at jobsite to avoid damage. Deliver all glazing accessory materials in manufacturer's original unopened containers, clearly marked as to their contents.

#### 7.2.12 STORAGE

Store all materials at the jobsite, in a manner assuring its safety from all forms of damage. Protect glass from soiling, condensation, etching, etc. Follow manufacturer's recommendation properly.

#### 7.2.13 GLAZING

Prevent glass from contact with metal or any hard or sharp materials by use of resilient shims placed at a quarter point. Use resilient sealants. Use stops in sizes permitting a "good grip" onto glass. Install glass only in opening that are rigid, plumb and square. Allow sufficient clearance at edges of glass to compensate for its expansion or for some settlement of the building. Clearance should be ¼ inch from edge to frame and 1/8 inch for face, marking, banners, posters and other decal should not be spelled directly to glass surface as these could cause thermal stresses. Removal of part of glazing compound smears from glass shall be performed by the glazing contractor during the materials normal work life. Failure to do so may result damage to the glass.

#### 7.2.14 Doors and Window Screen

All windows, main doors and exits shall be provided by aluminum and metal screen of best quality. Materials shall be as approved by the project manager.

### 7.3 Construction Requirements

#### 7.3.1 Installation of Doors

Doors shall be installed only after the completion of other works, which may affect the moisture content of the door. Doors shall be fitted and trimmed as required by the opening they will cover. Doors shall have a clearance of 3mm

at the side and top and shall have a bottom clearance of 6mm over thresholds or as shown on details. The lock edge shall be leveled at the rate of 3mm in 50mm. Cuts made on the jambs shall be sealed immediately after cutting, using a clear water-resistant varnish or sanding sealer.

Doors with surfaces receive paint finish may be furnish factory primed and doors with natural finish may be furnished factory pre-finished. Final furnishing shall be done in site in accordance with painting and varnishing specifications.

### 7.3.2 Installation of Window

Window framing and aluminum and steel frame shall be fitted closely, set accurately to the required lines and levels, and secured the place in a rigid manner with the use of appropriate fasteners. Frame corners shall be mitered and mechanically locked to attain extreme rigidity.

Steel casement and aluminum frame and glass shall be of the design, size and thickness as indicated. Steel casement and aluminum framing and clip shall be shop fabricated and shall be loosely pivoted to allow free movement. The leaves and blades shall be secured. Movable section of the window shall allow easy operation either to close or open operation.

Doors and windows screen shall be installed by well experience installer and shall be in accordance with the instruction of the project manager.

### 7.3.3 Installation of Builders Hardware

#### (1) Door knobs, lock and larch strikes

All lock and latch strike shall be installed in door frames at the same height from the floor. Door knob shall be so located that the center of the knob is 0.90 m from the finished floor.

#### (2) Butt Hinges

Each panel of hinged door shall be provided with two (2) butts for doors 1.50 m in height; three (3) butts, over 1.50 m high and not over 2.10 m in height. Doors of a greater height than 2.10 m unless otherwise specified, shall be provided w2ith an additional one (1) butt for each 0.65 m or fraction thereof.

Size of the Butt Hinges required as follows:

| Thickness of door           | Width of Door | Size of Butt Hinges |
|-----------------------------|---------------|---------------------|
| 21 mm or 25 mm (7/8" or 1") |               | 63 mm (2- 1/2 "     |

|                                     |                           |
|-------------------------------------|---------------------------|
| 28 mm (1- 1/8")                     | 75 mm x 75 mm (3" x 3")   |
| 44mm (1 - 3/4")                     | 100 mm x 100 mm (4" x 4") |
| 56 mm x 63 mm (2 - 1/4 "x 2 - 1/2") | 125 mm x 125 mm (5" x 5") |

#### 7.4 Method of Measurement and Basis of Payment

1. The quantities for doors to be paid for shall be the number of square meter and/or number of units of door panel completed and accepted. Payment of this item shall be deemed to include the cost of jambs, heads, door frames, nailers, glass pane (if any), lockset, hinges and finish hardware.
2. The quantities accomplished for steel or aluminum casement and glass jalousie windows shall be measured in square meters of area and/or number of units completed and accepted. Payments for these items shall be considered to include the cost of window jambs, sill, transom, mullions, glass jalousie, aluminum frames, mouldings and finished hardware.
3. The quantities accomplished for each type of steel window shall be paid in square meters of area and/or number of units completed and accepted for each item of work. Payment for this item shall be considered to include the cost of steel frames, glass panel, finished hardware, grills, moulding and glazing and incidental works.
4. The quantities accomplished for doors/windows screen shall be paid in square meters of area and/or number of units completed and accepted for each item of work. Payment for this item shall include the cost of aluminum frames, screen, accessories and other incidental works necessary to complete the work

The quantities measured as stipulated above, shall be paid for at the contract unit price for each item, which price and payments shall be fully compensation for furnishing and placing all materials, labor, equipments, tools and incidental necessary to complete the work described on this section.

### 8.0 FINISHES

#### 8.1 Scope of work

This section covers all works required in connection with surfaced finished on wood, metal, masonry and concrete surfaces in accordance with this specification and as shown in the drawings.

## 8.2 Material requirement

### 9.2.1 Plastering Works

#### (1) Portland Cement

Cement shall conform to ASTM standard C150, Type 1

#### (2) Sand

Fine aggregates for plastering shall be natural sand and shall be retained between No. 50 and No. 100 sieves

#### (3) Lime

It shall be dehydrated lime where the free (un-dehydrated) calcium oxide and magnesium oxide in the hydrated product shall not exceed 8 percent by weight.

#### (4) Water

Water used in mixing, shall be reasonably clean and free of oil, salt, acids, alkali, grass and other substances injurious to the finished product.

### 8.2.2 Tile Works

#### (1) Floor Tiles

Tiles shall be standard grade unglazed vitrified tiles and 6 mm thick. Color and pattern shall be as specified in the drawing or as approved by the Project Manager.

For all other floor finishes not indicated below, refer to schedule or call out specification of finishes indicated in the plan.

- 400 mm x 400 mm Vitrified Granite Tiles (at Lobby and Hallway of Second Floor only).
- 400 mm x 400 mm Vitrified Ceramic Tiles (at all Rooms except Operating Room, Delivery Room, Labor Room and Recovery Room);

- 400 mm x 400mm Vitrified Non-Skid Ceramic Tiles;
- 300 mm x 300 mm Non-Skid Rustic Floor Tiles (at all fire exit stair wells);
- 200 mm x 200mm Vitrified Non-Skid Ceramic Tiles at all Comfort Rooms or Toilets);
- 500 mm x 500 mm Rubber Floor Tiles (at Ramp Facility from ground floor to second floor);
- 2.0 Anti-bacterial and Anti-Septic Vinyl Flooring Roll Form (for Operating Room, Delivery Room, Labor Room and Recovery Room);
- 200 mm x 250mm Glazed Ceramic Wall Tiles (for walls of Comfort Rooms or Toilets and at areas indicated in the plans.

Glazed Wall Tiles – standard glaze bright or matte glazed. Square edge or cushion edge with integral approximately 8-millimeter (5/16 inch.) thick.

Vitrified Unglazed Floor Tiles – standard grade unglazed natural clay type dust-pressed or extruded approximately 6 millimeters (1/4 inch.) thick.

Accessories – soap holders and paper holders shall be recessed type to follow color specified.

Vinyl Floor Tiles – wherever indicated in the drawing shall be 2.0 mm thick or otherwise specified in the plans. Verify color, design and pattern.

## (2) GROUT MATERIALS

As required by the Project Manager or as follows:

Portland Cement Grout:

Scratch Coat: 1 part Portland Cement to 5 parts Sand to 1/5 part hydrated lime.

Mortal Bed: 1 part Portland Cement to 5 parts Sand to ½ part hydrated lime.

Bond Coat: neat Portland Cement Paste.

### (3) Wall and Wainscoting Tiles

It shall be 6 mm thick, standard grade, glazed vitrified tiles. Color and pattern shall be as shown in the drawing or as approved by. Tiles shall be free from lamination, serrated edges, chipped off corners and other imperfections affecting their quality, appearance and strength.

## 8.3 Construction Requirements

### 8.3.1 Cement Finish on Masonry Walls

#### 1) General

The work consists of furnishing all materials, labor and performing all operations in connection with plastering masonry wall surfaces, complete in every respect as shown in the drawings and as specified herein. Plastering work shall be protected properly from being damage during plastering operations, Scaffolding shall be amply strong, well braced, tied securely and inspected regularly. Overloading of scaffolding shall not be permitted.

#### (2) Mixing of Plaster

Except where hand mixing of small patches is an approved mechanical mixer of an approved type shall be used for the mixing of plaster. Materials shall be accurately measured by a device that will maintain the specified proportions within a plus or minus tolerance not in excess of 5% by volume. Plaster materials shall be accurately measured in approved containers to insure the specified proportions. Caked and mixing each batch and kept free of plaster from previous mixes. Plaster materials shall be thoroughly mixed with the proper amount of water until a uniform color and consistency is attained. Tempering shall not be permitted and all plaster that has begun to stiffen shall be discarded.

#### (3) Proportioning Plaster

Portland cement plaster shall be a two-coat application, the base and the finish coat. Each coat shall be proportioned as follows; One part by volume of Portland, to three parts sand. Hydrated lime may be used as directed by the Consultant.

Portland cement plaster shall be a two-coat application, the base and finish coat. Each coat shall be proportioned as follows; One part by volume of Portland, to three parts sand. Hydrated lime may be used as directed by the Consultant.

#### (4) Application of Plaster

Surface to receive plaster must be free from structural defects and shall be thoroughly dampened prior to application of plaster.

Plaster base coats shall be applied with sufficient pressure and the plaster shall be sufficiently plastic to provide good bond on masonry base. The base coat shall be compacted and straightened to a true surface without the application of water and the entire surface shall be floated to receive the finish coat. The finish coat shall be applied to a thickness approximately 3 mm before the scratch set. Maximum finish free from blemishes or irregularities. Trawling shall coath as be continued until the finish surface sets. Immediately after setting, surface shall be soured vigorously with clean burlap or cement bag paper or brush to remove the sheen finish produced by trawling.

Plaster work shall be finished level plumb, square and true, within a tolerance of 3mm in meters without waves, blisters, pits, crazing, discoloration, and projections or other imperfections. Plaster work shall be formed carefully around angles and contours, and well up to screens. Special care shall be taken to prevent consequent dropping of applications. There must be no visible junction marks where one day's work adjoins another. Finished work shall be protected in an approved manner to prevent damage.

#### (5) Portland Cement Plaster

Cement plaster shall have a total thickness of not less than 12 mm thick. The base coat shall be applied not less than 9 mm thick and allowed to dry slowly for 24 hours. Then the finish coat shall be applied to a thickness of not less than 3 mm and brushed with 4 applications of fog spray of clean water. The first spray shall be applied 12 hours after the finishing coat has been completed and three subsequent spraying shall be applied at sufficient intervals thereafter as approved by the consultants.

#### (6) Patching and Pointing

Upon completion of the work all loose, cracked, damage or defective plastering shall be cut and re-plastered in a satisfactory manner. All pointing and patching of plastered surfaces and where plastering abuts or adjoins any other finished works shall be done in a neat and workmanship manner ready to receive pain or other finish.

#### (7) Curing and protection

Dump curing shall begin as soon as the mortar has hardened sufficiently to prevent injury and water applied in a fog spray to keep the plaster damp throughout without soaking. The period for damp curing shall be specified for each coat protects the plaster from uneven and excessive evaporation during hot or drying weather conditions.

(8) Cleaning

After the completion of plastering work, all scaffolding surplus materials, debris and plaster daubs and stains in floors, windows and other surface shall be removed to the satisfaction and approved of the Project Manager.

8.3.2 Cement Finish on Concrete Floor Slabs

(1) General

This work includes plain cement finish with or without red cement, and plain cement finish as bed for tiles, including all labor, materials, equipment and other facility to complete, the work in accordance with the plans and specifications.

(2) Finishing Requirement

Floors and slabs shall be sloped uniformly to the drains, in areas where tiles are to be laid; the concrete base slab shall be depressed to not less than 50 mm, when not indicated. Floor and slab finishes where not indicated, shall receive a single steel trawling. Dry cement shall not be placed directly on the new concrete surface to absorb excess moisture

(3) Finishing Procedures for floors and slabs, where not indicated on the drawings, shall be as follows:

| Finish   | Description  | Uses  |
|----------|--|---|
| Screened | Rough, free from Ridges and holes                                    | Slab and concrete surfaces under earth fill   |
| Floated  | Medium rough with Texture finished                                   | Light storage areas, base slabs and heavy machine pads  |
| Trawled  | Fine and texture To flossy glass Finish depending Upon the number of | All surfaces:<br>1) under floor- 1 pass<br>2) normal wearing<br>3) Dense wearing surface-3 Passes |

(4) Screened Finish

Concrete shall be placed, consolidated and immediately struck off to bring the top surface of the slab to proper grade. Floors shall be leveled with a tolerance of 3mm in 3.0 m, except where drain occurs, in which case the floors shall be pitched to the drains. Striking off and bull floating shall be completed before water appears on the surface of the freshly-placed concrete. If water is still visible by the time floating is to start, the excess water shall first scrubbed off the surface by appropriate means.

(5) Floated Finish



Floating shall begin when the water sheen has disappeared and when the surface has stiffened sufficiently to support a man without indenting the surface. Floating shall be performed by hand with a wood float. During the floating, the surface shall be checked with a 3.0-m straight edge applied at different angles. The surface shall be floated to a true plane within 3 mm in 3.0 meters.

(6) Trowled Finish

Upon attaining proper set, the floor shall first be given a floated finish as specified herein above and then hand trowled. The first trowling should produce a smooth surface free of defects. The finished surface shall be free of trowled marks, uniform in texture and true to a plane within 3mm in 3.0 meters.

(7) Broomed Finish

The floor shall first be given a floated and a steel trowled finish as specified herein above and then surface shall be broomed with flexible bristle broom. The topping mixture shall be spread evenly over the roughened base before the final set has taken place. At the time of brooding, the trowled surface shall have hardened sufficiently to retain the scoring on ridges. The brooding shall be in a direction transverse to that of traffic or at right angles to the slope of the floor.

(8) Mixing of Red Cement

Red cement shall be thoroughly dry, mixed with fresh Portland cement using dry and clean equipment. The proportion shall be three (3) parts red cement to one (1) part Portland cement. Cement top finish shall be one (1) part Portland cement-red cement mix and one (1) part sand, mix with minimum water content.

(9) Application of Cement Finishes

The concrete slab to receive cement top finish shall be roughened before the concrete has set. Before applying the cement top finish, the concrete surface shall be further roughened with a pick of similar tool remove laitance, loose particles, plaster and anything that would prevent bond and then cleaned by an approved method of device. After cleaning, the slab shall be thoroughly wet before top finish is applied. The cement top finish shall have a minimum thickness of 19 mm and shall be poured continuously until the entire section is complete. Cement top finish shall be floated either manually or machine, struck off with straight edge, steel trowled to a hard smooth surface, and graded to drain where required. Where the floor is to be hardened, ½ of the pre-mixed floor hardener shall be spread over the freshly poured cement top finish after screening and removing any excess water from the mixture and the floor shall then be floated. The balance of pre-mixed floor hardener shall be evenly spread over, the surface at the right angles to the first application. The floor shall then be floated and care shall be taken to embed the floor topping with hardener firmly in surface of the concrete floor. The treated cement top shall be allowed firmly in surface of the concrete floor.

The treated cement top shall be allowed to set sufficiently so that the surface maybe steel trowled to a hard-scaled surface.

### 8.3.3 Other Cement Finish

#### (1) Patching of Surface Defect

All surface defects shall be repaired with cement mortar of the same composition as used in the concrete. Part of the cement in the mortar may be white cement, for patching exposed areas to match the color of the surrounding concrete. Patching shall begin as soon as the forms are removed and areas to be patched are cleaned thoroughly minor defective areas shall be cut out of the solid concrete to a depth of not less than 25 mm. And edges of cuts shall be perpendicular to the surface of the concrete. Area to be patched and about 150 mm of the adjacent surrounding areas approximately one (1) hour before placing and remix occasionally during this period without adding water an initial cement and water mixed to the consistency of paint of the required grout of color shall be applied into the surface to which the mortar is to be bonded.

#### (2) Repairing of Structural Defects

Concrete with excessive honey-comb, exposed reinforcing bars and other defects which affect the structural strength of the members shall be removed and repaired by the contractor to the satisfaction of the Project Manager.

#### (3) Finishing of Formed Surfaces

Finishing of formed surfaces, where not indicated in the drawings, shall be as follows:

- (a) Surfaces exposed to public view shall be smooth form finished no plastering work shall be done on exposed surfaces to correct imperfections. Form facing materials shall be used to produce a smooth, hard and uniform texture on the concrete. Tie holes and defects shall be patched and all fins shall be completely removed.
- (b) Surfaces not exposed to public view shall be rough form finished. Tie holes and defects shall be patched and fins exceeding 6 mm in height shall be chipped off or rubbed off.
- (c) Finishing of formed surfaces shall be accomplished after removal and repair of surface defects.

### 8.3.4 Tile Works

(1) General

The work consists of furnishing all materials, labor and performing all operations in connection with tile finishing of floors and walls, complete including mortar beds for the tile. Tile work shall not be started on portions where embedded lines crossed-over the area until roughing-ins for plumbing and electrical work has been completed and tested. The work of all other trades in a workmanship manner as directed by the Project Manager tile setting temporary screeds shall be applied to the scratch coat to provide a true and plumb surface to the proper distance back from the finished wall. The setting bed shall be applied, rotted and floated flushed with the screeds over an area n greater than will be covered with the tile while the bed remains plastic. The thickness of the setting bed shall not exceed 20 mm and the mortar shall not be tempered.

(2) Mortar for Tiles

Scratch coat for wall tile shall consist of one part Portland cement, ¼ part lime putty and 3 parts sand by volume. Scratch coat shall have a minimum thickness of 9mm the buttering mortar for setting wall tiles and mortar setting bed for floor tiles shall have the same proportion as that of scratch coat.

(3) Floor Tiling

(a) Preparation of Surfaces

Before tile is applied with a dry-set mortar bed, the structural floor shall be tested for levelness or uniformity of slope by flooding it with water. Areas with ponds shall be filed, leveled and resetting before the setting bed is applied. The slab shall be soaked thoroughly with clean water on the day before the setting bed is applied. Immediately preceding the application of the setting bed, the slab shall again be wetted thoroughly but, no free water shall then be applied not more than 1.5 m thick. The mortar shall be spread until its surface is true and even and thoroughly compacted, either level or slope uniformly for drainage, where required. A setting bed, as far as can be covered with the tile before the mortars have reached its initial set, must be placed in one (1) operation, but in the event that more setting mortar has been placed that can be covered, the unfinished portion shall be removed and cut back to a clean leveled edge.

(b) Application of Floor Tile

All tiles to be soaked in the clean water to a minimum of one (1) hour before they are installed. Placing tile on a wetted cloth in a shallow pan before installing shall damp absorptive mounted tile. Before the initials set has taken place in the setting bed, a skim of Portland cement mortar

75 mm to 1.5 mm thick may be hand dusted uniformly over the setting bed and worked lightly with a trowel or brush until thoroughly damp. The tiles shall then be pressed firmly upon the setting bed, and carefully tapped into the mortar until true and even with the place of the finished floor base. Tapping and leveling shall be completed within one (1) hour after placing tiles. Borders and defined lines shall be laid before the field or body of the floor. Where floor drain is provided, the floor shall be sloped properly to the drains. Cutting of tiles, where necessary, shall be done along the outer edges of the tile against trim, base, thresholds, pipes, built- in fixtures and similar surfaces and shall be geared and joined carefully. Tiles shall be removed and replaced to the satisfaction of the project Manager. All lines shall be kept straight, parallel and true all finished surface brought to true and even plane.

(4) Wall Tiling

(a) Preparation of Surfaces

Scratch coat shall be applied on prepared surface to serve as backing for wall tiles, not less than 24 hours or more than 48 hours before starting the tile setting. Temporary screeds shall be applied to the scratch coat to provide a true and plumb surface to the proper distance back from the finished wall. The setting bed shall be applied, rotted and floated flushed with the screeds over an area in greater than will be covered with the tile while the bed remains plastic. The thickness of the setting bed shall not exceed 20 mm and the mortar shall not be tempered.

(b) Application of Wall Tile

Tiles shall be soaked in clean water for a minimum of one (1) hour before they are installed. A skim coat Portland cement mortar mixed with water to the consistency of thick cream. 75 mm thick shall be applied to the mortar setting bed, or to the back of each tile. The tiles shall then be pressed firmly upon the setting bed and tapped until flush and even plane of the other tiles. The tiles shall be applied before the mortar bed has taken its initial set. Intersections and returns shall be formed accurately. All lines shall be kept straight and true: and all finished corners rounded. Horizontal joints shall be maintained level and joints plumb alignment.

(5) Jointing

Joints shall be parallel and uniform in width, plumb, and level and in alignment end joints in broken-joint shall be made, as far as practicable; on the center line of the adjoining tiles. Joint widths shall be uniform and measured to accommodate the tiles in the given spaces with a minimum curing.

(6) Grouting

Grouting shall be done using the approved materials of the Project Manager. Grouting shall be done as soon as the mortar beds have sufficiently set. All

cement shall be Portland cement, colored or white, as required. Where light colored mortar is required in joints, mixture of white cement and non-fading mineral oxide shall be used to produce the desired color. The quantity of mineral oxides shall not exceed 10% of the volume of the cement in any case.

(7) Cleaning

Upon completion of grouting, the tile shall be thoroughly cleaned and maintained in this condition until completion of the contract.

8.4 Method of Measurement and Basis of Payment

The finished area to be paid for under each item shall be measured by the number of square meter painted surfaces accepted in accordance with the plans and specifications. The cost of plastering works, tinting color, thinner, sandpaper, putty including mixing, application, curing, false work and protection work shall be deemed to be included in the contract unit price for each pay item as shown in the bid schedule.

The finished area to be paid for tiles surfaces shall be measured by the number of square meters accepted in accordance with the plans and specifications. The cost of tile trims, plastering, grout adhesive and other required materials as per plans shall be deemed to be included in the contract unit price for each day item as shown in the bid schedule.

The accepted quantities measured as stipulated above shall be paid for at the contract unit price for each of the particular pay item listed below, which price and payment shall be full compensation for furnishing and placing all materials, labor, equipment, tools and incidentals necessary to complete each work item.

**9.0 PLUMBING WORKS**

9.1 Scope of Work

The item shall consist of furnishing all materials, tools, equipment and fixtures required as shown on the plans for the satisfactory performance for the entire plumbing system including installation in accordance with the latest edition of the National Plumbing Code and this Specification.

9.2 Material Requirements

This item shall consist of furnishing all materials, tools, equipment and fixtures required as shown on the Plans for the satisfactory performance of the entire plumbing system including installation in accordance with the latest edition of the National Plumbing Code, and this Specification.

- 9.2.1 For cold water lines, Pn 10 Fusion Weld Polypropylene Pipes. Provide coal tar with burlap for embedded pipe.
- 10.2.2 UPVC Pipe series 1000 conforming to ASTM D-2729 for all downspouts and sewer waste & vent lines.
- 9.2.3 Water Closets shall be Tank Type Plush Button Flush. Free Standing Combination round front bottom outlet siphon vortex or wash-down bowl with jet round front with close coupled tank with cover with complete fittings and mounting accessories.
- 9.2.4 Toilet lavatories shall be Pedestal Type, Wall hung lavatory with rear overflow and cast-in soap dishes pocket hanger and integral China Brackets complete with twin faucets, supply pipes, P-trap and mounting accessories.
- 9.2.5 Scrub-up Sink made of Ga. # 16 stainless steel material with round edges and corners. Complete with imported water valves as knee control, adjustable shower head and drain assembly.
- 9.2.5.1 Installation
- a. Align & mark flange holes for drilling, the top of the flange must be 20" from the floor.
  - b. Bolt knee control assembly flanges to the wall.
  - c. Connect UNION fitting to in house water source pipe.
  - d. Bolt in sink brackets 36" from the floor. Keep it centered with the knee controls and drain pipe.
  - e. Connect flexible plastic hose to shower head water supply.
  - f. Install Drain and P-trap.
  - g. Install shower head assembly.
- 9.2.6 Laboratory Sink Ga#16 stainless steel deep seated seamless single bowl compartment with back splash and Tubular C – spout faucet completes with fittings and accessories.
- 9.2.7 Laboratory Sink Ga#16 stainless steel deep seated single bowl compartment with back splash and Tubular C spout faucet complete with fittings and accessories.
- 9.2.8 Laboratory Sink Ga#16 stainless steel deep seated single bowl compartment incorporated with Drain Board, 150mm height back splash complete tubular goose neck faucet, fittings and accessories.
- 9.2.9 Where indicated in the plans, the counter top model make and color shall be approved by the Architect or Engineer.
- 9.2.10 Stainless steel working sink shall be used to all working counters. It shall be made of stainless steel self-riming, single compartment complete with supply fittings, strainer traps, dual control lever and other accessories, fitted to actual requirement as shown in the plans.
- 9.2.11 Pipes, plumbing fixtures, water lines, clean out and vents shall be supplied and installed in accordance with the approved workmanship.

#### 9.2.12 Septic Tank/Placenta Pit

The septic tank and placenta pit shall be provided as shown on the plans including all pipe vents and fittings.

Various construction materials such as concrete masonry work shall conform to the corresponding items of this specification.

Inlet and outlet pipes shall conform to the latest edition of the National Plumbing Code.

#### 9.2.10 Water Supply Pipes and Fitting

A. Pipes shall be PN 10 Fusion Weld Polypropylene Pipe conforming to specification requirements including Trims and Fittings.

B. Valves for water supply shall be bronze body with threaded ends rated 21.0 kgf/cm square. All valves are gate valves unless otherwise specified. Gate valves shall have solid wedge body and discs conforming to specification requirements defined in ASTM B-52. Globe valves shall have plug type disc with ferrule-threaded ends and bronze body.

C. Unions in ferrous pipe 50 mm in diameter and smaller shall be malleable iron.

#### 9.2.11 Approved Alternate Pipes and Fittings

Pipes and fittings for sanitary and potable water lines as approved alternative shall be Galvanized Iron Pipes and Fittings Schedule 40 and Unplasticized Polyvinyl Chloride Pipes and Fittings (UPVC). Pipes and fittings shall be made of virgin materials conforming to specification requirements defined in ASTM D-2241 and PNS 65: 1986. Fittings shall be molded type and designed for solvent cement joint connection for water lines and rubber O-ring seal joint for sanitary lines.

### 9.3 Construction Requirements

The Contractor before any installation work is started shall carefully examine the Plans and shall investigate actual structural and finishing work condition affecting all this work. Where actual condition necessities a rearrangement of the approved pipe layout for approval by the Project Manager.

#### 9.3.1. Installation of Waste and Vent Pipes

10.3.1 a. Horizontal lines shall be secured strongly by hooks to the building frame and suitable brackets or chairs shall be provided at the floor which they start.

9.3.1 b. Vent pipes in roof spaces shall be run as closest possible to under side of the roof with horizontal piping pitched down to the stacks without forming traps. Vertical vent pipes connected into one main vent riser above the highest vented fixtures.

9.3.1 c. Where an end circuit vent pipe from any fixtures is connected to a vent line serving other fixtures, the connection shall be at least 1.20 m above the floor on which the fixtures are located.

- 9.3.1 d. Horizontal waste line receiving the discharge from two or more fixtures shall be provided with end vents separate venting of fixtures is noted on the plans.
- 9.3.1 e. All changes in pipe size on soil and waste lines shall be made with reducing fittings or recessed reducers. All changes in direction shall be made appropriate use of 45 degrees, wyes, half wyes, quarter bends or elbows may be used in waste lines where the change in direction of flow is horizontal to the vertical and on the discharge from waste closets. Where it becomes necessary to use short radius fittings in other location the approval of the Project Manager shall be obtained prior to the installation of the same.
- 9.3.1 f. Vent pipe shall be provided with Vent Cap (Studor) and flashed and made watertight at the roof with ferrule lead. Flashing shall be turned down into pipes.

### 9.3.2 Water Pipes, Fittings, and Connections

All water piping inside the building and underground, 100-mm in diameter and smaller shall be schedule 40, series 1000 PVC pipes fittings.

- 9.2.3 a. The water piping shall be extended to all fixtures, outlets and equipment from the gate valves installed in the branch neat the rise.
- 9.2.3 b. The cold-water system shall be installed with a fall towards a main shut off valve drain. Ends of pipes and outlet shall be capped or plugged and left ready for future connections.
- 9.2.3 c. Mains and Branches.
- 9.2.3 d. All pipes shall be cut accurately to measurements and shall be worked into places without springing or forcing. Care shall be taken so as to not to weaken the structural portions of the building.
- 9.2.3 e. All piping above the ground shall be run parallel with the lines of the building unless otherwise indicated on the plans.
- 9.2.3 f. All service pipes, valves and fittings shall be kept at sufficient distance from other work to permit finished covering on the different services.
- 9.2.3 g. No water piping shall be buried in floors, unless specifically indicated on the Plans and approved by the Project Manager
- 9.2.3 h. Changes in pipes shall be made with reducing fittings.
- 9.2.3 i. Drain Cocks  
Pipe drain indicated on the drawing shall consist of 12-mm globe valve with renewable disc and installed at low points on the cold water piping so that all piping shall slope 100 in 30.5 m.
- 9.2.3 j. Threaded Pipe Joints



All pipes shall be reamed before threading. All screw joints shall be made with graphite and oil or with an approved granite compound applied to make threads only. Threads shall be cut not more than three threads on the pipe shall remain exposed.

9.2.3 k. Expansion and Contraction of Pipes

Accessible contraction expansion joints shall be made whenever necessary. Horizontal runs of pipe over 15 m length shall be anchored to the wall to the supporting structure about midway on the run to force expansion and the contraction equally toward the ends or as shown on the Plans.

- Valves shall be provided on all supplied fixtures as herein specified.
- The cold-water connection to the return circulation connection shall have and a check valve.
- All connection to domestic hot water heaters shall be equipped with unions between valve and tanks.
- Valve shall not be installed with its stem below the horizontal. All valves shall be gate valves unless otherwise indicated on the Plans.
- Valves to and including 50-mm diameter shall be threaded ends; rough bodies and finished trimmings, except those on chromium plated brass pipe.
- Valves 63 mm in diameters and larger shall have iron bodies, brass mounted and shall have either screws or flange ends.
- Hose bibs shall be made of brass with 12.5-mm inlet threads, hexagon shoulders and mm male.

9.3.3 Fixtures, Equipment and Fastenings

- 9.3.3 a. All fixtures and equipment shall be supported and fastened in a safe and satisfactory workmanship as practiced.
- 9.3.3 b. All fixtures were required to be wall mounted on concrete or concrete hollow block wall, fasten with brass and expansion bolts. Expansion bolt shall be 6-mm diameter with 20-mm threads to 25 mm into solid concrete, fitted with loose tubing to sleeves of proper length to acquire extreme rigidity.
- 9.3.3 c. Inserts shall be securely anchored and properly flushed into the walls. Inserts shall be concealed and rigid.
- 9.3.3 d. Bolts and nuts shall be horizontal and exposed. It shall be provided with washers and chromium plate finish.

9.3.4 Plates and Flashing

- 9.3.4 a. Plates to cover exposed pipes passing through floor finished walls or ceiling shall be fitted with chromium plated cast brass plates or chromium plated cast iron steel on ferrous pipes.
- 9.3.4 b. Plates shall be large enough to cover and close the hole around the area where pipes pass. It shall be properly installed to ensure permanence.
- 9.3.4 c. Roof areas penetrated by vent pipes shall be rendered watertight by lead-sheet flashing and condor flashing. It shall extend at least 150 mm above the pipe and 300 mm along the roof.

#### 9.3.5 Bathroom and Toilet Accessories

- a. Shower head and fittings shall be movable, cone type with escutcheon arm with stainless steel; shower valve and control lever. All exposed surface to be chromium finish.
- b. Grab bars shall be made tubular stainless-steel pipe provided with safety grip and mounting flange for disabled people.
- c. Floor drains shall be made of steel beehive type, measuring 10 cm x 10 cm and provided with detachable stainless strainer, expanded metal lath type.
- d. Toilet paper and soap holder shall be vitreous chine or approved equal wall mounted. Color shall reconcile with the adjacent fixture and facing tiles.
- e. Faucets shall be made of stainless steel for interior use.
- f. Hose bibs shall be made of bronze cast finish.

#### 9.4 Drainage System Test

- 9.4.1 The entire drainage and venting system shall have all necessary openings, which can be plugged to permit the entire system to be filled with water to the level of the highest water or a full 30 minutes during which time there shall be no drop greater than 102 mm.
- 9.4.2 Where only a portion of the system is to be tested, the test shall be conducted in the same manner as described for the entire system except that a vertical stack 3.00 m highest horizontal line to be tested may be installed and filled with water to maintain sufficient pressure or water pump may be used to supply required pressure.
- 9.4.2 If and when the Project Manager decides that an additional test is needed, such as an air to smoke test on the drainage system, the Contractor will perform such test without any designated representative.

#### 9.5 Water Test on System

9.5.1 Upon completion of the roughing-in and before connecting fixtures the entire cold water piping system shall be tested at a hydrostatic pressure 1 ½ times the expected working pressure in the system during operation and remained tight and leaked-proofed.

9.5.2 Where piping system is to be concealed the piping system and in the presence of the Engineer of his duty designated representative.

#### 9.6 Defective Work

9.6.3 All defective materials replaced and tested will be repeated until satisfactory performance is attained.

9.6.4 Any material replaced for the satisfactory performance of the system made shall be at the expense of the Contractor.

9.6.5 Caulking of screwed joints or holes will not be permitted.

#### 9.7 Disinfection

9.7.1. The entire water distribution system shall be thoroughly flushed and treated with chlorine before it is operated for public use.

9.7.2 Disinfection materials shall be liquid chlorine or hydro-chloride and shall be introduced in a manner approved as practice or potable water.

9.7.3. Valves for the water distribution system shall be opened and closed several times during 16 hours chlorinating treatment is done.

#### 9.8 Method of Measurement and Basis of Payment

The work done under this item shall be quantified per length and/or number of units as provided in the Bill of Quantities, tested and accepted to the satisfaction of the Project Manager. The accepted quantities measured shall be paid at the contract unit price and payment shall be full compensation including labor, materials (pipes, fittings, etc.) and incidentals necessary to complete this item.

### **10.0 ELECTRICAL WORKS**

#### 10.1 WORK INCLUDED

All work under these specifications shall consist of furnishing/cause to furnish materials, labor, tools, appliances, and all other services necessary unless otherwise indicated to complete and make ready for operation, the electrical power, lighting, and other utility system described herein and/or indicated in the electrical plans including owner-furnished equipment and fixtures. In accordance with the electrical plans and these specifications.

1. To secure and pay for all permits, certificates, and other related permits.
2. To secure and pay for the insurance required for the project.

3. Roughing-in and wiring for lighting, power, telephone, fire alarm, nurse call, and paging system.
  4. Supply, installation, and testing of panel boards, and disconnect switches.
  5. Supply and installation of boxes, pull boxes, auxiliary gutters, wire gutters, bus bar gutters, circuit breaker gutters and the like.
  6. Supply and installation of lighting fixtures, switches, ceiling fans and power outlets.
  7. Supply and installation of hangers and supports of conduits for power, feeder and sub-feeder system and auxiliary system.
  8. Painting of electrical works covering conduits, boxes, hangers, gutters, and the like.
  9. Testing for electrical system:
    - a. Insulation Resistance test
    - b. Operational test
    - c.
- 10.1.1 Anything that has been omitted in any of work or materials usually furnished which are necessary for the completion of the works as outlined herein shall be undertaken or supplied by the contractor included in this division of work and must be included in the bid proposal.

## 10.2 CODE REGULATIONS

All materials and equipment to be used in the electrical installations and construction shall be in accordance with the provisions of the latest edition of the Philippine Electrical Code and the pertinent ordinances of the municipality wherein the project is located.

All work shall comply with the rules and regulations of the local power utility company in so far, they are concerned in providing the respective permanent services to the building.

## 10.3 DRAWING AND SPECIFICATIONS

The electrical plans and these specifications are meant to be complementary to each other, and what is called for in one shall be as binding as if called for by both.

*Any conflict between the electrical plans and this specification and any unclear points of controversial matter in either shall be referred to the owner's assigned representative for final decision and resolution.*

Upon final completion of the work herein described, the electrical contractor shall furnish the Owner two (2) copies of the "As-built" plans for future reference and maintenance purposes.

The electrical plans indicate the general layout of the complete electrical system, arrangement of feeders, circuit outlets, switches, controls, panel boards, service equipment and other work. Field verification of the scale dimensions on the plane

must be made, since actual locations, distances and levels will be governed by actual field conditions.

The Electrical Contractor shall check architectural, structural, and plumbing plans if necessary to resolve such conflicts. The Electrical Contractor shall notify the architect and secure approval and agreement on necessary adjustments before installation is started.

#### 10.4 PERMITS AND INSPECTION

The Electrical Contractor shall obtain all necessary permits and certificates of electrical inspection from the proper government authorities concerned, required both for the performance of the work involved and the operation of the system upon completion of the work.

The Electrical Contractor shall pay all the fees necessary to secure the above-mentioned permits and certificates.

The Electrical Contractor shall at his own expense, reproduce the electrical plans to the necessary scale and size, complete them with all the necessary information and requirements as maybe government authorities concerned with the approval of plans.

The Electrical Contractor shall coordinate with the local power company regarding the power facilities and secure approval of the power requirements.

#### 10.5 MATERIALS AND WORKMANSHIP

All materials to be used shall be brand new, with trade name, unused, and shall in every case be the best where such standards have been established for the particular type of materials used.

Trade/brand name of materials indicated in the specifications are re-commendatory in nature and are included for the purpose of uniformity in bids. *If trade/brand names other than those indicated are to be used during construction, brochures and samples shall be submitted to the end user's representative for approval.*

Only skilled workmen using proper tools and equipment shall be employed during the entire course of the installation work. All workmanship shall be of the best quality and all works shall be done in accordance with the best engineering practice of the trade involved.

#### 10.6 WIRING METHOD

Lighting and Power Branch Circuit –uPVC pipes concealed in ceilings and double walls and/or embedded in concrete walls/slabs. All uPVC pipes ran underground outside of buildings shall be buried not less than 40mm below natural grade line and enclosed in concrete envelope. All concrete envelopes passing under the roadways or areas accessible to vehicles shall be steel reinforced up to 1.0m from the edge of the roadway.

Fire Alarm System Layout – rigid Upvc conduits concealed in ceiling and double walls and/or embedded in concrete walls/slabs.

Low Voltage Service Entrance and All Feeders – rigid uPVC conduits, exposed/concealed in ceiling/double walls, embedded in concrete walls/slabs or ran underground and encased in concrete.

All Other Auxiliary Layout – uPVC pipes concealed in ceilings/double walls and/or embedded in concrete walls/slabs.

Use flexible uPVC pipes for connection between junction boxes inside ceiling and lighting and other fixtures using approved fittings.

All boxes, cabinets and other equipment shall be flush-mounted unless specified/approved otherwise.

All boxes for lighting outlets, convenience outlets, tumbler switches and other devices shall be galvanized pre-painted and approved products of reputable manufacturers. Cut ends of conduits shall be reamed and cleaned to remove burr and sharp edges. Threads cut on conduits shall be the same thread dimensions as factory cut conduits threads. Conduits joints shall be made straight and true. Elbows and offsets and changes in direction and runs shall be uniform. Bends shall be made without kinking or destroying the cross-sectional contours of the conduits. Conduit terminals shall be provided at outlet boxes and cabinets with lock nuts and blushing. Conduits shall be continuous from outlet and from outlet to pull boxes and cabinets in the manner that the conduit system shall be electrically continuous.

Where conduit runs are exposed, they shall be supported at an interval of not more than 0.75 m maximum with proper clamps and bolts or expansion shields or other means of support.

All splices, taps, junction in wires larger than 8.0 sq. mm shall be done with solderless connectors of suitable sizes and properly insulated with rubber tapes and protected by friction tapes, so that the insulation strength shall at least be equal to the insulation of the conductors they join.

Unless otherwise specified, the types of wires to be used shall either be THW or THHN. Smallest size of wire to be used for lighting and power unless otherwise indicated shall be 3.5 sq. mm.

#### 10.7 FEEDERS

Feeders shall be laid out in accordance with the riser diagram shown in the electrical plans.

Unless otherwise specified type THW or THHN wires shall be used for feeder lines. The wires and conduits sizes in the electrical plans shall be the minimum sizes to be used.

#### 10.8 WALLS SWITCHES AND RECEPTACLES

All wall switches shall be flush type and mounted 1.40 meters above finish floor line unless otherwise specified.

Convenience outlets shall be grounding type, wall flushed, mounted 0.30 meter above finished floor line or finished counters unless otherwise specified in the plan.

Ground fault circuit interrupter protected convenience outlets shall be used in bathrooms, lavatories, sinks, laundry area, and the like.

#### 10.9 MAIN SWITCHES, TRANSFER SWITCHES, PANEL BOARDS

The cabinet for the above shall be of standard sizes and shall be gauge #18. Circuit breakers shall be as specified in the plan and shall be followed at all times.

#### 10.10 LIGHTING FIXTURES

Install all lighting fixtures and lamps as specified and as shown on plans, fluorescent lamps shall either be 48 inches/40 watts or 24 inches/20 watts, standard cool white or daylight with the minimum light output of 3,000 lumens. Use high power factor ballast.

All fluorescent fixtures housing shall be US Gauge 22 minimum.

Submit one sample of each type of fixtures to the Architect or Resident Electrical Engineer for approval prior to manufacturing and installation.

#### 10.11 AUXILLIARY SYSTEMS

The electrical contractor shall supply, install, test and commission a complete fire alarm system as specified in the electrical plan.

The electrical contractor shall coordinate with and at his own expense pay all the required fees by

the local telephone and CATV providers to ensure the complete operation and connection of

the said systems. The electrical contractor shall, after completion, submit a complete schematic

wiring diagram of the telephone and CATV system to the Owner.

#### 10.12 TRADE/BRAND NAMES

For the purpose of having conformity in bids, the following trade or brand names are hereby recommended where applicable, to wit:

Wires and Cables- use Philflex, Columbia, Phelps Dodge or approved equal

uPVC Conduits and accessories- use Neltex, Emerald, Moldex, Atlanta, or approved equal.

Rigid Steel Conduits- use Seah Steel, Wheatland or approved equal

Lighting Fixtures- use GE, Toshiba, Philips or approved equal  
Lamps/Ballasts- use Philips, GE, Toshiba or approved equal  
Switches & Outlets- use National, Toshiba, Anamor approved equal  
Fire Alarm Devices- use Himmax, ASI, or approved equal  
PABX- use Neax, Panasonic, Aiphone or approved equal  
Panelboards/CktBreakers,Transfer Switches- use Square D,GE, Siemens or approved equal.  
Distribution Transformer- use Philec, ABB, Wagner or approved equal  
Metering Instruments- use GE or trade names approved by the local electric utility Company  
Generator Sets- use Perkins, Cummins, Caterpillar or approved equal  
Air Conditioning Units- use Carrier, Condura, or approved equal  
Exhaust fans- use Standard, 3D, KDK or approved equal  
Tapes- use Nitto, 3M, or approved equal

#### 10.13 DISTRIBUTION TRANSFORMERS and GENERATOR SET

The electrical contractor shall supply and install/cause to install distribution transformers, distribution lines, transformer pads, grounding system, and metering system for the building where applicable.

The electrical contractor shall supply and install/cause to install a Stand-by Generator Set for the building where applicable.

The electrical contractor shall coordinate with, pay the required fees at his own expense, and secure approval from the local electric utility company as to the type and quality of materials to be used for the works mentioned above where applicable.

#### 10.14 GUARANTEE

The Electrical Contractor shall guarantee his work, including materials and equipment used, to be free from defects and failures for a period of one (1) year from date of acceptance of the Owner, with which time he shall replace defective materials or equipment and repair any defect or failure in any part of the system.



## **11.0 PAINTING WORKS**

### **GENERAL**

General Requirements contain provisions and requirements essential to these Specifications; and apply to this section, whether or not referred to herein.

### **SCOPE OF WORK**

This Section covers the surface preparation, coating materials and application of coatings systems required for the Works.

The work shall consist of furnishing of all labor, materials, equipment and other incidentals necessary for the supply of painting materials and the complete painting of surfaces as shown on the drawings in accordance with this Specification and as directed by the Engineer.

The term paint as hereinafter used includes latex, silver aluminum, oils, pigments, thinner and dryers.

All exposed metal surfaces, except metal surfaces embedded in concrete, shall be painted unless otherwise specified.

### **STANDARD**

The following publications listed below, but referred to thereafter by basic designation only, forms a part of these Specifications to the extent indicated by the reference thereto:

Steel Structures Painting Council (SSPC) U.S. Specification JIS K 5628 Red-lead Zinc Chromate Anti-Corrosive Paint.

### **STORAGE AND DELIVERY**

1. The Contractor shall deliver all material to the site in the original labeled sealed cans and containers, with labels intact and seal unbroken.
  - a. Seals shall remain unbroken until after inspection and acceptance of material by the Engineer.
  - b. The Contractor shall deliver materials in ample quantities sufficiently in advance of the need to avoid any delay or interruptions in the works.
2. Paint in thinner shall be stored in accordance with the approved manufacturer's instructions.
  - a. All regulations required for storage of paint shall be observed and all

necessary safety signs required by governing codes shall be posted.

- b. Any damage caused by failure to exercise proper precautions in paint storage shall be repaired.

***MATERIAL REQUIREMENTS***

**PAINT**

Paints for the protective coating system shall be the product of a manufacturer approved by the Engineer.

Paints for exterior finish must be with tile like durability and elegance, fast drying, solvent based acrylic, highly suitable for coastal or polluted areas with excellent anti-fungus properties and alkali resistance.

100% Acrylic, water based, quick-drying, easy to clean-up and environmentally friendly, resist dirt, stains, alkali, water, humidity, algae, mold and mildew growth and highly durable paint for interior finish.

An all-purpose synthetic quick dry paint for all types of wood and metal surfaces. It has high gloss, good color retention and outstanding durability.

For pipes, valves and equipment, galvanized and ungalvanized ferrous metal, use a 100% acrylic gloss paint, has excellent resistance to ultraviolet rays and resists chalking, cracking and color fading, dries fast and environmentally friendly.

**SCHEDULE OF PAINTING**

Paint manufacturers shall be BOYSEN, DAVIES or approved equal.

|                                   |  |
|-----------------------------------|--|
| Architectural Items               |  |
| a. Exterior Finishes              |  |
| 1. On Concrete Walls              |  |
| Two Coats, Concrete Masonry Paint | DV Megacryl, DV Liquid Tile, DV Fusion, DV Elastogel |
| 2. On Plaster                     |  |

|                                   |   |
|-----------------------------------|---|
| First Coat<br>Pigmented sealer    | Optimal Liquid Tile Clear,<br>Optimal Liquid Tile<br>Pigmented or approved<br>equal |
| Second Coat<br>Enamel undercoated | DV 1350 Primer and<br>Sealer or approved<br>equal                                   |
| Third Coat                        | Megacryl Latex (semi-<br>gloss / flat)<br>or approved equal                         |

## EXECUTION

### SURFACE PREPARATION OF CONCRETE AND PLASTER

Concrete and cement plaster surfaces to be painted shall be prepared by removing efflorescence, dust, dirt, grease, oil, asphalt, tar, excessive mortar and mortar dropping and by roughening to remove glaze. A zinc sulfate solution shall be applied before prime coat.

### MIXING AND THINNING

Mixing and thinning of paint shall be done in accordance with the approved manufacturer's printed instructions. The pot life of each paint as stated by the manufacturer shall not be exceeded.

### WEATHER CONDITION

The paint shall not be applied when the relative humidity is above 85 percent. The paint shall not be applied in rain, wind, fog, dust or mist.

### APPLICATION

Workmanship shall be first class in every respect. All work shall be done in a workmanship manner so that the finished surfaces shall be free from runs, chop, ridges, waves, laps and unnecessary brushmarks. All coats shall be applied in such manner as to produce an even film of uniform thickness. Edges, corners, crevices, welds and rivets shall receive special attention to ensure that they receive an adequate thickness of paint.

All painting shall be done by thoroughly experienced workmen.

Safety regulations shall be adhered to at all times, including the wearing of respirators by persons engaged on assisting in spray painting. Adjacent areas and installation shall be protected by the use of cloths or other approved precautionary measures.

Plain enamel and varnish shall be applied carefully with good clean brushes or approved spraying equipment, except that the initial coat on any surface shall be applied with brush. Sufficient time shall be allowed between coats to assure thorough drying and each coat shall be in proper condition before receiving the next coat.

Sanding and dusting as required shall be performed between coats in varnishing work. Finish coat shall be smooth and free from runs, sags, and other defects. Exterior paint shall not be applied during rainy days.

All paint when applied shall provide a satisfactory film and smooth, even surface. Paint shall be thoroughly stirred and kept at a uniform consistency during application. Powdered metallic pigments added at the time of use shall be mixed by adding the powder in small increments to about one-third of the base paint or vehicle, with thorough mixing to obtain a smooth paste. The remainder of the base paint shall then be thoroughly stirred in.

Different brands of emulsion paints shall not be mixed prior to application of the materials.

Where necessary to suit conditions of surface temperature, weather and method of application, the package paint may be thinned immediately prior to application in accordance with the approved manufacturer's directions, but not in excess of 125 cc of suitable thinner per liter (one pint per gallon). Before using, the paint shall be mixed to a uniform consistency and shall be stirred frequently during application.

Paints other than water-thinned paints shall be applied only to surfaces which are completely free of moisture as determined by sight or touch and only such combinations of humidity to be painted as will cause evaporation rather than condensation.

Surfaces which have been cleaned, pre-treated and/or otherwise been prepared for painting shall be primed or painted with one coat of finish paint as soon as practicable after such preparation has been completed, but in any event prior to any deterioration of the prepared surfaces.

The first coat of paint on all exterior surfaces shall be applied by brush. Interior prime coats and all other subsequent coats on either exterior or interior surfaces may be applied by brush or spray. Whenever spraying is permitted all areas inaccessible to spray painting shall be coated by brushing or other suitable means. Brushes to be used for application of water-emulsions shall be soaked in water for a period of 2 hours prior to use.

All cloths and cotton waste which might constitute a fire hazard shall be placed in closed metal containers or destroyed at the end of each day.

Upon completion of the work, all staging, scaffolding, and containers shall be removed from the site or destroyed in a manner approved by the Engineer. Paint spots, or stains upon adjacent surfaces shall be removed and the entire job left clean and acceptable to the Engineer.

No smoking shall be permitted in the vicinity where painting is going on.

#### TOUCH-UP PAINTING

Touch-up painting shall be done with the same paint as used for the original coat. The resulting minimum dry film shall be the same as for the original coat.

Touch-up painting shall include cleaning and painting of field connections, welds and all damaged or defective paint and rusted areas.

During touch-up painting, only loose, cracked, brittle or non-adherent paint shall be removed during cleaning. All exposed edges shall be feathered. Touch-up painting shall be performed in a manner which will minimize damage to sound paint. Rust spots shall be thoroughly cleaned and edges of the existing paint shall be scraped back to sound material.

#### DRYING

1. No primer or paint shall be forced to be dried under conditions which will cause cracking, wrinkling, blistering, formation of pores which would detrimentally affect the condition of the paint.
2. No drier shall be added to the paint unless specified in the approved manufacturer's instructions.
3. Painted surfaces shall be protected from dust, dirt, and the elements of the weather until dry to the fullest extent practicable.
4. After drying, any areas of paint damaged from any cause shall be removed, the surface again prepared and then touched-up with the same paint and to the same thickness as the undamaged areas as specified in sub-section 4.14.3.7 above.

#### HANDLING

1. Precautions shall be taken to minimize damage to paint films resulting from stacking for drying.
2. Paint which is damaged in handling shall be scraped off and touched-up with

the same paint and in the same thickness as was previously applied to the damaged area at Contractor's expense.

#### INSPECTION

1. All works and materials supplied under this Specification shall be subject to inspection by the Engineer.
2. The Contractor shall correct such works or replace such materials found defective under these Specifications at his own expense.

### **12.0 SAFETY SIGNAGES AND BARRICADES**

#### **Specifications**

The Signage's and Barricades shall be installed at location(s) designated by the Engineer.

The sizes of the standard signage shall be 2-2/3ft x 4ft (800 X 1,200mm) for fixed type and 2ft x 2-2/3ft (600mm x 800mm) for mobile type. For barricade standard 2ft x 2-2/3ft (600mm x 800mm) shall be provided.

The materials to be used for signage and barricades are ½ inch (12mm) marine plywood or tarpaulin poster on 2" x 2" (50mm x 50mm) good lumber frame.

The printing or painting shall be the discretion of the Engineer.

## ***Section VII. Drawings***

## ***Section VIII. Bill of Quantities***

### **Notes on the Bill of Quantities**

#### **Objectives**

The objectives of the Bill of Quantities are:

- a. to provide sufficient information on the quantities of Works to be performed to enable Bids to be prepared efficiently and accurately; and
- b. when a Contract has been entered into, to provide a priced Bill of Quantities for use in the periodic valuation of Works executed.

In order to attain these objectives, Works should be itemized in the Bill of Quantities in sufficient detail to distinguish between the different classes of Works, or between Works of the same nature carried out in different locations or in other circumstances which may give rise to different considerations of cost. Consistent with these requirements, the layout and content of the Bill of Quantities should be as simple and brief as possible.

#### **Daywork Schedule**

A Daywork Schedule should be included only if the probability of unforeseen work, outside the items included in the Bill of Quantities, is high. To facilitate checking by the Entity of the realism of rates quoted by the Bidders, the Daywork Schedule should normally comprise the following:

- a. A list of the various classes of labor, materials, and Constructional Plant for which basic daywork rates or prices are to be inserted by the Bidder, together with a statement of the conditions under which the Contractor will be paid for work executed on a daywork basis.
- b. Nominal quantities for each item of Daywork, to be priced by each Bidder at Daywork rates as Bid. The rate to be entered by the Bidder against each basic Daywork item should include the Contractor's profit, overheads, supervision, and other charges.

#### **Provisional Sums**

A general provision for physical contingencies (quantity overruns) may be made by including a provisional sum in the Summary Bill of Quantities. Similarly, a contingency allowance for possible price increases should be provided as a provisional sum in the Summary Bill of Quantities. The inclusion of such provisional sums often facilitates budgetary approval by avoiding the need to request periodic supplementary approvals as the future need arises. Where such provisional sums or contingency allowances are used, the SCC should state the manner in which they will be used, and under whose authority (usually the Procuring Entity's Representative's).



The estimated cost of specialized work to be carried out, or of special goods to be supplied, by other contractors should be indicated in the relevant part of the Bill of Quantities as a particular provisional sum with an appropriate brief description. A separate procurement procedure is normally carried out by the Procuring Entity to select such specialized contractors. To provide an element of competition among the Bidders in respect of any facilities, amenities, attendance, etc., to be provided by the successful Bidder as prime Contractor for the use and convenience of the specialist contractors, each related provisional sum should be followed by an item in the Bill of Quantities inviting the Bidder to quote a sum for such amenities, facilities, attendance, etc.

**Signature Box**

A signature box shall be added at the bottom of each page of the Bill of Quantities where the authorized representative of the Bidder shall affix his signature. Failure of the authorized representative to sign each and every page of the Bill of Quantities shall be a cause for rejection of his bid.

These Notes for Preparing a Bill of Quantities are intended only as information for the Procuring Entity or the person drafting the Bidding Documents. They should not be included in the final documents.

**MINISTRY OF TRANSPORTATION AND COMMUNICATIONS**

**BILL OF QUANTITIES**

PROJECT TITLE: CONSTRUCTION OF RIVER LANDING AT TUGAL, SULTAN SA BARONGIS, MAGUINDANAO

| ITEM NO.   | DESCRIPTION  | QTY       | UNIT   | UNIT BID COST | AMOUNT |
|--|--|-----------|--------|---------------|--------|
| <b>PART A. OTHER GENERAL REQUIREMENTS</b>            |  |           |        |               |        |
| A.1.1(3)   | Construction of Field Office for the Engineering                       | 1.00      | L.s    |               |        |
| B.3  | Permits and Clearances   | 1.00      | L.s    |               |        |
| B.5  | Project Billboard/Signboard  | 2.00      | Each   |               |        |
| B.7 (1)  | Occupational Safety & Health Program                                   | 12.00     | months |               |        |
| B.9  | Mobilization/Demobilization  | 1.00      | L.s    |               |        |
| <b>PART B. EARTHWORKS</b>                            |  |           |        |               |        |
| 104(5)   | Boulder Fill   | 52.08     | cu.m.  |               |        |
| 800(1)   | Clearing & Grubbing  | 600.00    | sq.m.  |               |        |
| 803(1)a  | Structural Excavation (Common Soil)                                    | 201.75    | cu.m.  |               |        |
| 804(1)b  | Embankment from Common Borrow by Equipment                             | 826.08    | cu.m.  |               |        |
| 804(4)   | Gravel Bedding   | 20.81     | cu.m.  |               |        |
| <b>PART C. PLAIN &amp; REINFORCED CONCRETE WORKS</b> |  |           |        |               |        |
| 900(1)   | Structural Concrete for Column, Beam, Suspended Slab(Class A, 28 Days) | 81.97     | cu.m.  |               |        |
| 900(1)c2   | Structural Concrete for , Footing, Grade Slab, and Stair               | 290.96    | cu.m.  |               |        |
| 901(1)   | Lean Concrete (for manual mixing)                                      | 3.94      | cu.m.  |               |        |
| 902(1)   | Reinforcing steel of Reinforced Structure for One Storey Building      | 35,103.66 | kg     |               |        |
| 903(2)   | Formworks & Falseworks (For one Storey Building)                       | 1,477.50  | sq.m.  |               |        |
| 1052(5)a   | Precast, Prestressed Concrete Piles, furnished (400 mm x 400 mm).      | 60.00     | m      |               |        |
| 1052(14)a  | Precast Concrete Piles, driven (soft strata)                           | 60.00     | m      |               |        |
| 1052(6)  | Structural Steel Sheet Piles, furnished                                | 1,410.00  | m      |               |        |
| 1052(12)   | Structural Steel Sheet Piles, driven                                   | 1,410.00  | m      |               |        |
| <b>PART D. ARCHITECTURAL WORKS</b>                   |  |           |        |               |        |
| 1046   | 100mm CHB Non Load Bearing/Load Bearing (Including Reinforcing Steel)  | 346.36    | sq.m.  |               |        |
| 1046a  | 150mm CHB Non Load Bearing/Load Bearing (Including Reinforcing Steel)  | 192.36    | sq.m.  |               |        |
| 1027(1)  | Cement Plaster Finish  | 1,170.21  | sq.m.  |               |        |
| 1027(3)  | Decorative Stone   | 142.73    | sq.m.  |               |        |
| 1018(1)  | Glazed Tiles and Trims   | 56.45     | sq.m.  |               |        |
| 1018   | Unglazed Tiles   | 490.80    | sq.m.  |               |        |
| 1003(1)  | 4.5mm Fiber Cement Board on Metal Frame Ceiling                        | 326.16    | sq.m.  |               |        |
| 1032(1)a   | Painting Works (Masonry Painting)                                      | 1,496.37  | sq.m.  |               |        |
| 1032(1)b   | Painting Works (Metal Painting)  | 214.00    | sq.m.  |               |        |
| 1008   | Aluminum Glass Window (SlidingType)                                    | 5.06      | sq.m.  |               |        |
| 1010(2)a   | Hollow Core Flush Door   | 2.10      | sq.m.  |               |        |
| 1043(1)  | PVC Doors and Frames   | 4.52      | sq.m.  |               |        |
| 1003(17)   | Carpentry and Joinery ( Panolong)                                      | 1.00      | Ls     |               |        |
| 1003(17)   | Signage and Logo   | 1.00      | L.s    |               |        |
| 1051(1)  | Railings   | 10.00     | l.m    |               |        |
| 1400(4)  | Bollard  | 8.00      | sets   |               |        |
| SPL-2  | Pasenger Terminal Waiting Chair  | 15.00     | sets   |               |        |
| <b>PART E. FENCING WORKS</b>                         |  |           |        |               |        |
| 604(1)   | Fencing Barbed Wire  | 90.00     | l.m    |               |        |
| 604(2)   | Fencing Chain Link (Cyclone Wire)                                      | 90.00     | l.m    |               |        |
| 604(3)   | Fencing Post (Steel Pipe)  | 50.00     | each   |               |        |
| 604(4)   | Fencing Frames (Steel Pipe)  | 252.00    | each   |               |        |
| 1006   | Fencing gate   | 6.30      | sq.m   |               |        |
| <b>PART F. ROOFING AND STRUCTURAL STEEL WORKS</b>    |  |           |        |               |        |
| 1013(2)  | Fabricated Metal Roofing Accessories (Ridge Roll)                      | 34.90     | m      |               |        |
| 1014   | Prepainted Metal Sheet Long Span                                       | 450.00    | sq.m.  |               |        |
| 1036(1)a   | Polycarbonate  | 40.00     | lm     |               |        |
| 1047(2)b   | Structural Steel Roof Trusses  | 1,526.61  | kg     |               |        |
| 1047(1)  | Structural Steel Roof Framing ( Canopy)                                | 1.00      | L.s    |               |        |
| 1047(2)c   | Structural Purlins   | 994.40    | kg     |               |        |
| 1047(3)b   | Metal Structure Accessories (Sagrod)                                   | 20.00     | pc     |               |        |
| 1047(3)c   | Metal Structure Accessories (Turnbucke)                                | 56.00     | pc     |               |        |
| 1047(3)b   | Metal Structure Accessories (Crossbracing)                             | 27.00     | pc     |               |        |
| <b>PART G. PLUMBING WORKS</b>                        |  |           |        |               |        |
| 1001(8)  | Sewer Line Works   | 1.00      | l.s    |               |        |
| 1002(5)  | Plumbing Fixtures  | 1.00      | l.s    |               |        |
| 1002(6)  | Cold Waterline Pipes and Fittings                                      | 1.00      | l.s    |               |        |
| 1001(11)   | Septic Vault ( Concrete/CHB)   | 1.00      | l.s    |               |        |
| <b>PART H. ELECTRICAL WORKS</b>                      |  |           |        |               |        |
| 1100(30)   | Conduits, Boxes & Fittings, Conduit Works/Conduit Rough-in             | 1.00      | l.s    |               |        |
| 1100(42)   | Wires and Wiring Devices   | 1.00      | l.s    |               |        |
| 1102   | Panel Board with Main Breaker/Branches                                 | 1.00      | l.s    |               |        |
| 1103(1)  | Lighting Fixtures  | 1.00      | l.s    |               |        |
| 1106(1)  | Cctv System  | 1.00      | L.s    |               |        |
| <b>PART I. MECHANICAL WORKS</b>                      |  |           |        |               |        |
| 1200   | Air Conditioning & Refrigeration System                                | 1.00      | L.s.   |               |        |
| <b>TOTAL PROJECT COST</b>                            |  |           |        |               |        |

AMOUNT IN WORDS: \_\_\_\_\_

Submitted By : \_\_\_\_\_  
(Name of Firm)

Signing Authority : \_\_\_\_\_  
(Printed Name and Signature)

Designation : \_\_\_\_\_

Date : \_\_\_\_\_

**Bid Form for the Procurement of Infrastructure Projects**  
*[shall be submitted with the Bid]*

---

**BID FORM**

Date : \_\_\_\_\_  
Project Identification No. : \_\_\_\_\_

To: *[name and address of Procuring Entity]*

Having examined the Philippine Bidding Documents (PBDs) including the Supplemental or Bid Bulletin Numbers *[insert numbers]*, the receipt of which is hereby duly acknowledged, we, the undersigned, declare that:

- a. We have no reservation to the PBDs, including the Supplemental or Bid Bulletins, for the Procurement Project: *[insert name of contract]*;
- b. We offer to execute the Works for this Contract in accordance with the PBDs;
- c. The total price of our Bid in words and figures, excluding any discounts offered below is: *[insert information]*;
- d. The discounts offered and the methodology for their application are: *[insert information]*;
- e. The total bid price includes the cost of all taxes, such as, but not limited to: *[specify the applicable taxes, e.g. (i) value added tax (VAT), (ii) income tax, (iii) local taxes, and (iv) other fiscal levies and duties]*, which are itemized herein and reflected in the detailed estimates,
- f. Our Bid shall be valid within the a period stated in the PBDs, and it shall remain binding upon us at any time before the expiration of that period;
- g. If our Bid is accepted, we commit to obtain a Performance Security in the amount of *[insert percentage amount]* percent of the Contract Price for the due performance of the Contract, or a Performance Securing Declaration in lieu of the the allowable forms of Performance Security, subject to the terms and conditions of issued GPPB guidelines<sup>1</sup> for this purpose;
- h. We are not participating, as Bidders, in more than one Bid in this bidding process, other than alternative offers in accordance with the Bidding Documents;
- i. We understand that this Bid, together with your written acceptance thereof included in your notification of award, shall constitute a binding contract between us, until a formal Contract is prepared and executed; and
- j. We understand that you are not bound to accept the Lowest Calculated Bid or any other Bid that you may receive.
- k. We likewise certify/confirm that the undersigned, is the duly authorized representative of the bidder, and granted full power and authority to do, execute and perform any and all acts necessary to participate, submit the bid, and to sign

<sup>1</sup> currently based on GPPB Resolution No. 09-2020

- a. We likewise certify/confirm that the undersigned, is the duly authorized representative of the bidder, and granted full power and authority to do, execute and perform any and all acts necessary to participate, submit the bid, and to sign and execute the ensuing contract for the [Name of Project] of the [Name of the Procuring Entity].
- b. We acknowledge that failure to sign each and every page of this Bid Form, including the Bill of Quantities, shall be a ground for the rejection of our bid.

Name: \_\_\_\_\_

Legal Capacity: \_\_\_\_\_

Signature: \_\_\_\_\_

Duly authorized to sign the Bid for and behalf of: \_\_\_\_\_

Date: \_\_\_\_\_

## **Bid Securing Declaration Form**

*[shall be submitted with the Bid if bidder opts to provide this form of bid security]*

---

REPUBLIC OF THE PHILIPPINES)  
CITY OF \_\_\_\_\_) S.S.

### **BID SECURING DECLARATION** Project Identification No.: *[Insert number]*

To: *[Insert name and address of the Procuring Entity]*

I/We, the undersigned, declare that:

1. I/We understand that, according to your conditions, bids must be supported by a Bid Security, which may be in the form of a Bid Securing Declaration.
2. I/We accept that: (a) I/we will be automatically disqualified from bidding for any procurement contract with any procuring entity for a period of two (2) years upon receipt of your Blacklisting Order; and, (b) I/we will pay the applicable fine provided under Section 6 of the Guidelines on the Use of Bid Securing Declaration, within fifteen (15) days from receipt of the written demand by the procuring entity for the commission of acts resulting to the enforcement of the bid securing declaration under Sections 23.1(b), 34.2, 40.1 and 69.1, except 69.1(f), of the IRR of RA No. 9184; without prejudice to other legal action the government may undertake.
3. I/We understand that this Bid Securing Declaration shall cease to be valid on the following circumstances:
  - a. Upon expiration of the bid validity period, or any extension thereof pursuant to your request;
  - b. I am/we are declared ineligible or post-disqualified upon receipt of your notice to such effect, and (i) I/we failed to timely file a request for reconsideration or (ii) I/we filed a waiver to avail of said right; and
  - c. I am/we are declared the bidder with the Lowest Calculated Responsive Bid, and I/we have furnished the performance security and signed the Contract.

IN WITNESS WHEREOF, I/We have hereunto set my/our hand/s this \_\_\_\_ day of *[month]* *[year]* at *[place of execution]*.

*[Insert NAME OF BIDDER OR ITS AUTHORIZED  
REPRESENTATIVE]  
[Insert signatory's legal capacity]  
Affiant*

**Omnibus Sworn Statement (Revised)**  
*[shall be submitted with the Bid]*

---

REPUBLIC OF THE PHILIPPINES )  
CITY/MUNICIPALITY OF \_\_\_\_\_ ) S.S.

**AFFIDAVIT**

I, [Name of Affiant], of legal age, [Civil Status], [Nationality], and residing at [Address of Affiant], after having been duly sworn in accordance with law, do hereby depose and state that:

1. *[Select one, delete the other:]*

*[If a sole proprietorship:]* I am the sole proprietor or authorized representative of [Name of Bidder] with office address at [address of Bidder];

*[If a partnership, corporation, cooperative, or joint venture:]* I am the duly authorized and designated representative of [Name of Bidder] with office address at [address of Bidder];

2. *[Select one, delete the other:]*

*[If a sole proprietorship:]* As the owner and sole proprietor, or authorized representative of [Name of Bidder], I have full power and authority to do, execute and perform any and all acts necessary to participate, submit the bid, and to sign and execute the ensuing contract for [Name of the Project] of the [Name of the Procuring Entity], as shown in the attached duly notarized Special Power of Attorney;

*[If a partnership, corporation, cooperative, or joint venture:]* I am granted full power and authority to do, execute and perform any and all acts necessary to participate, submit the bid, and to sign and execute the ensuing contract for [Name of the Project] of the [Name of the Procuring Entity], as shown in the attached [state title of attached document showing proof of authorization (e.g., duly notarized Secretary's Certificate, Board/Partnership Resolution, or Special Power of Attorney, whichever is applicable)];

3. [Name of Bidder] is not "blacklisted" or barred from bidding by the Government of the Philippines or any of its agencies, offices, corporations, or Local Government Units, foreign government/foreign or international financing institution whose blacklisting rules have been recognized by the Government Procurement Policy Board, **by itself or by relation, membership, association, affiliation, or controlling interest with another blacklisted person or entity as defined and provided for in the Uniform Guidelines on Blacklisting;**

4. Each of the documents submitted in satisfaction of the bidding requirements is an authentic copy of the original, complete, and all statements and information provided therein are true and correct;

5. [Name of Bidder] is authorizing the Head of the Procuring Entity or its duly authorized representative(s) to verify all the documents submitted;

6. *[Select one, delete the rest:]*

*[If a sole proprietorship:]* The owner or sole proprietor is not related to the Head of the Procuring Entity, Procurement Agent if engaged, members of the Bids and Awards Committee (BAC), the Technical Working Group, and the BAC Secretariat, the head of the Project Management Office or the end-user unit, and the project consultants by consanguinity or affinity up to the third civil degree;

7. *[Name of Bidder]* complies with existing labor laws and standards; and
8. *[Name of Bidder]* is aware of and has undertaken the responsibilities as a Bidder in compliance with the Philippine Bidding Documents, which includes:
  - a. Carefully examining all of the Bidding Documents;
  - b. Acknowledging all conditions, local or otherwise, affecting the implementation of the Contract;
  - c. Making an estimate of the facilities available and needed for the contract to be bid, if any; and
  - d. Inquiring or securing Supplemental/Bid Bulletin(s) issued for the *[Name of the Project]*.
9. *[Name of Bidder]* did not give or pay directly or indirectly, any commission, amount, fee, or any form of consideration, pecuniary or otherwise, to any person or official, personnel or representative of the government in relation to any procurement project or activity.
10. **In case advance payment was made or given, failure to perform or deliver any of the obligations and undertakings in the contract shall be sufficient grounds to constitute criminal liability for Swindling (Estafa) or the commission of fraud with unfaithfulness or abuse of confidence through misappropriating or converting any payment received by a person or entity under an obligation involving the duty to deliver certain goods or services, to the prejudice of the public and the government of the Philippines pursuant to Article 315 of Act No. 3815 s. 1930, as amended, or the Revised Penal Code.**

IN WITNESS WHEREOF, I have hereunto set my hand this \_\_ day of \_\_, 20\_\_ at \_\_\_\_\_, Philippines.

*[Insert NAME OF BIDDER OR ITS AUTHORIZED REPRESENTATIVE]*  
*[Insert signatory's legal capacity]*  
 Affiant



**Statement of Availability of Key Personnel and Equipment**

(Date of Issuance)

**ATTY. PAISALIN P. TAGO, CPA**

Minister

Ministry of Transportation and Communications RH7, Bangsamoro Government Compound  
Cotabato City

Attention : The Chairman

Bids and Awards Committee

Dear Sir / Madame:

In compliance with the requirements of the (Name of the Procuring Entity) BAC for the bidding of the (Name of the Contract), we certify that (Name of the Bidder) \_\_\_\_\_ has in its employ key personnel, such as project managers, civil engineers, architect, materials engineer and safety officer, who may be engaged for the construction of the said contract.

Further, we likewise certify the availability of equipment that (Name of the Bidder) owns, has under lease, and/or has under purchase agreements, that may be used for the construction contracts.

Very truly yours,

(Name of Representative) (Position)  
(Name of Bidder)

**List of Equipment Owned (please see Invitation to Bid), assigned to the Proposed Contract**

Business Name \_\_\_\_\_

Business Address \_\_\_\_\_

| Description | Model/Year | Capacity/<br>Performance/size | Plate<br>No. | Motor no./<br>Body no. | Location | Condition | Proof of<br>Ownership |
|-------------|------------|-------------------------------|--------------|------------------------|----------|-----------|-----------------------|
|             |            |                               |              |                        |          |           |                       |
|             |            |                               |              |                        |          |           |                       |
|             |            |                               |              |                        |          |           |                       |
|             |            |                               |              |                        |          |           |                       |
|             |            |                               |              |                        |          |           |                       |
|             |            |                               |              |                        |          |           |                       |

List of minimum equipment required for the project:

Submitted by:

(Printed Name & Signature)

Designation:

Date: \_

**Qualification of Key Personnel Proposed to be Assigned to the Contract**

Business Name : \_\_\_\_\_

Business Address : \_\_\_\_\_

|                       | Project Engineer | Material Engineer | Safety Officer | Structural Engineer | Construction Foreman | Skilled Laborer | Unskilled Laborer |
|-----------------------|------------------|-------------------|----------------|---------------------|----------------------|-----------------|-------------------|
| 1 Name                |                  |                   |                |                     |                      |                 |                   |
| 2 Address             |                  |                   |                |                     |                      |                 |                   |
| 3 Date of Birth       |                  |                   |                |                     |                      |                 |                   |
| 4 Employed Since      |                  |                   |                |                     |                      |                 |                   |
| 5 Experience          |                  |                   |                |                     |                      |                 |                   |
| 6 Previous Employment |                  |                   |                |                     |                      |                 |                   |
| 7 Education           |                  |                   |                |                     |                      |                 |                   |
| 8 PRC License         |                  |                   |                |                     |                      |                 |                   |

Minimum Requirements:

- : Project Engineer
- : Material Engineer
- : Safety Officer
- : Structural Engineer
- : Construction Foreman
  
- : Skilled Laborer
- : Unskilled Laborer

Note: Attached individual resume, PRC License of the (professional) personnel, Certificate of DPWH Accreditation, Certification as Structural Engineer and Certificate of Trainings from any training institutions recognized by the Department of Labor and Employment (DOLE) for Safety Officer.

Designation : \_\_\_\_\_

Date : \_\_\_\_\_

**Statement of all Completed Government & Private Construction Contracts which are similar in nature**

Business Name : \_\_\_\_\_  
 Business Address : \_\_\_\_\_

| Name of Contract  | a. Owner Name<br>b. Address<br>c. Telephone Nos. | Nature of Work | Contractor's Role |   | a. Amount at Award<br>b. Amount at Completion<br>c. Duration | a. Date Awarded<br>b. Contract Effectivity<br>c. Date Completed |
|-------------------|--|----------------|-------------------|---|--|---|
|                   |  |                | Description       | % |  |   |
| <u>Government</u> |  |                |                   |   |  |   |
|                   |  |                |                   |   |  |   |
|                   |  |                |                   |   |  |   |
|                   |  |                |                   |   |  |   |
|                   |  |                |                   |   |  |   |
|                   |  |                |                   |   |  |   |
|                   |  |                |                   |   |  |   |
| <u>Private</u>    |  |                |                   |   |  |   |
|                   |  |                |                   |   |  |   |
|                   |  |                |                   |   |  |   |
|                   |  |                |                   |   |  |   |

Note: This statement shall be supported with:  
 1 Contract  
 2 CPES rating sheets and/or Certificate of Completion  
 3 Certificate of Acceptance

Designation : \_\_\_\_\_  
 Date : \_\_\_\_\_



## ***Section IX. Checklist of Technical and Financial Documents***

### **Notes on the Checklist of Technical and Financial Documents**

The prescribed documents in the checklist are mandatory to be submitted in the Bid, but shall be subject to the following:

- a. GPPB Resolution No. 09-2020 on the efficient procurement measures during a State of Calamity or other similar issuances that shall allow the use of alternate documents in lieu of the mandated requirements; or
- b. any subsequent GPPB issuances adjusting the documentary requirements after the effectivity of the adoption of the PBDs.

The BAC shall be checking the submitted documents of each Bidder against this checklist to ascertain if they are all present, using a non-discretionary “pass/fail” criterion pursuant to Section 30 of the 2016 revised IRR of RA No. 9184.

# Checklist of Technical and Financial Documents

## I. TECHNICAL COMPONENT ENVELOPE

### *Class "A" Documents*

#### Legal Documents

- (a) Valid PhilGEPS Registration Certificate (Platinum Membership) (all pages);  
**Or**
- (b) Registration certificate from Securities and Exchange Commission (SEC), Department of Trade and Industry (DTI) for sole proprietorship, or Cooperative Development Authority (CDA) for cooperatives or its equivalent document;  
**And**
- (c) Mayor's or Business permit issued by the city or municipality where the principal place of business of the prospective bidder is located, or the equivalent document for Exclusive Economic Zones or Areas;  
**And**
- (e) Tax clearance per E.O. No. 398, s. 2005, as finally reviewed and approved by the Bureau of Internal Revenue (BIR).

#### Technical Documents

- (f) Statement of the prospective bidder of all its ongoing government and private contracts, including contracts awarded but not yet started, if any, whether similar or not similar in nature and complexity to the contract to be bid; **and**
- (g) Statement of the bidder's Single Largest Completed Contract (SLCC) similar to the contract to be bid, except under conditions provided under the rules;  
**and**
- (h) Philippine Contractors Accreditation Board (PCAB) License;  
**or**  
Special PCAB License in case of Joint Ventures;  
**and** registration for the type and cost of the contract to be bid; **and**
- (i) Original copy of Bid Security. If in the form of a Surety Bond, submit also a certification issued by the Insurance Commission;  
**or**  
Original copy of Notarized Bid Securing Declaration; **and**
- (j) Project Requirements, which shall include the following:
  - a. Organizational chart for the contract to be bid;
  - b. List of contractor's key personnel (e.g., Project Manager, Project Engineers, Materials Engineers, and Foremen), to be assigned to the contract to be bid, with their complete qualification and experience data;
  - c. List of contractor's major equipment units, which are owned, leased, and/or under purchase agreements, supported by proof of ownership or certification of availability of equipment from the equipment lessor/vendor for the duration of the project, as the case may be; **and**
- (k) Original duly signed Omnibus Sworn Statement (OSS);

**and** if applicable, Original Notarized Secretary's Certificate in case of a corporation, partnership, or cooperative; or Original Special Power of Attorney of all members of the joint venture giving full power and authority to its officer to sign the OSS and do acts to represent the Bidder.

Financial Documents

- (l) The prospective bidder's audited financial statements, showing, among others, the prospective bidder's total and current assets and liabilities, stamped "received" by the BIR or its duly accredited and authorized institutions, for the preceding calendar year which should not be earlier than two (2) years from the date of bid submission; **and**
- (m) The prospective bidder's computation of Net Financial Contracting Capacity (NFCC).

**Class "B" Documents**

- (n) If applicable, duly signed joint venture agreement (JVA) in accordance with RA No. 4566 and its IRR in case the joint venture is already in existence; **or** duly notarized statements from all the potential joint venture partners stating that they will enter into and abide by the provisions of the JVA in the instance that the bid is successful.

**II. FINANCIAL COMPONENT ENVELOPE**

- (o) Original of duly signed and accomplished Financial Bid Form; **and**

Other documentary requirements under RA No. 9184

- (p) Original of duly signed Bid Prices in the Bill of Quantities; **and**
- (q) Duly accomplished Detailed Estimates Form, including a summary sheet indicating the unit prices of construction materials, labor rates, and equipment rentals used in coming up with the Bid; **and**
- (r) Cash Flow by Quarter.





*Republic of the Philippines*  
MINISTRY OF TRANSPORTATION & COMMUNICATION  
**OFFICE OF THE MINISTER**

BARMM  
COTABATO CITY



DETAILED ENGINEERING DESIGN FOR  
CONSTRUCTION OF RIVER LANDING  
AT TUGAL, SULTAN SA BARONGIS,  
MAGUINDANAO

CHECKED & SUBMITTED BY:

  
**ENGR. NASRODDIN B. MASAKAL**  
ENGINEER IV

RECOMMENDING APPROVAL BY:

  
**ATTY. ROSLAINE L. MACAO-MANIRI**  
DIRECTOR GENERAL

APPROVAL BY:

  
**ATTY. PAISALIN P. TAGOCAPA**  
MINISTER



**A** PERSPECTIVE VIEWS  
SCALE: 1:500M

**TABLE OF CONTENT**

**ARCHITECTURAL**

- AR-00 PERSPECTIVE VIEW, VICINITY MAP, MASTER SITE DEVY PLAN
- AR-01 NOTES & SYMBOL
- AR-02 GROUND FLOOR PLAN
- AR-03 ROOF DECK PLAN
- AR-04 ELEVATIONS
- AR-05 SECTIONS
- AR-06 STAR DETAILS
- AR-07 TOILET & WASH DETAILS
- AR-08 DOORS & WINDOWS SCHEDULES
- AR-09 DETAILS



**B** LOCATION / VICINITY MAP  
SCALE: NTS

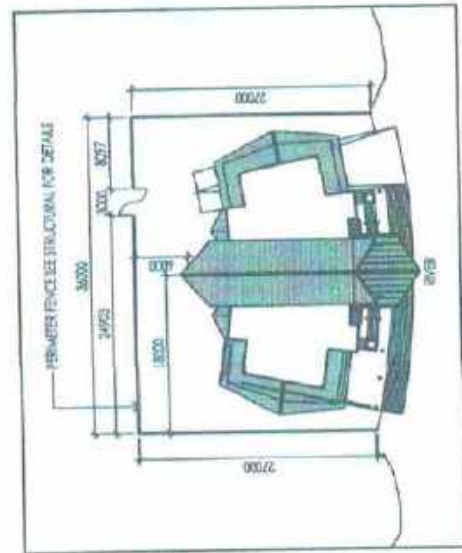

**C** SITE DEVELOPMENT PLAN  
SCALE: 1:500M

REPUBLIC OF THE PHILIPPINES  
OFFICE OF THE CITY / MUNICIPALITY  
ENGINEER / BUILDING OFFICIAL  
DISTRICT / CITY / MUNICIPALITY

LAND USE & ZONING

LINE & GRADE

ARCHITECTURAL

SANITARY

DATE: ELECTRICAL

DATE: MECHANICAL

|   |   |  |   |                             |
|---|---|--|---|-----------------------------|
| <p>Department of Transportation and Communications<br/>OFFICE OF THE MINISTER<br/>BUREAU OF ROAD AND TRANSPORT BUILDERS</p> | <p>PROJECT LOCATION:<br/>CONSTRUCTION OF RIVER LANONG AT TUGAL, SULTAN SA BARONGSI, MANGUENANAO</p> | <p>SHEET CONTENT:<br/>VICINITY MAP, SITE DEVELOPMENT PLAN AND TABLE OF CONTENT</p> | <p>DATE: 10/10/2023</p>                               | <p>PROJECT NO: 2023-001</p> |
|   | <p>PROJECT NO: 2023-001</p>   | <p>DATE: 10/10/2023</p>  | <p>PROJECT NO: 2023-001</p>                           | <p>PROJECT NO: 2023-001</p> |
| <p>APPROVED BY: </p> <p>ATTY. FABIAN R. MACABALAN</p>   | <p>DESIGNED AND DRAWING BY: </p> <p>ENGR. GERVASIO A. ALMORAR</p>                                   | <p>CHECKED AND REVIEWED BY: </p> <p>ENGR. GERVASIO A. ALMORAR</p>                  | <p>APPROVED BY: </p> <p>ATTY. FABIAN R. MACABALAN</p> | <p>PROJECT NO: 2023-001</p> |

**STANDARD HATCHES**

|  |                   |
|--|-------------------|
|  | PLAIN CONCRETE    |
|  | R. CONCRETE       |
|  | MASONRY (MU)      |
|  | STONE (SECTION)   |
|  | STEEL (SECTION)   |
|  | METAL (ELEVATION) |
|  | SAND              |

|  |                         |
|--|-------------------------|
|  | PLASTER (SECTIONS)      |
|  | COMPACTED SOIL          |
|  | GRAVEL / PEBBLES        |
|  | SPANISH TILES           |
|  | GLASS (ELEVATIONS)      |
|  | WAVY GLASS (ELEVATIONS) |
|  | GLASS (SECTIONS)        |

|  |                     |
|--|---------------------|
|  | INSULATION          |
|  | WATER               |
|  | PLYWOOD             |
|  | WOOD (ELEVATION)    |
|  | WOOD (ELEVATION)    |
|  | HARD WOOD (SECTION) |
|  | SRC / GRP           |

|  |                    |
|--|--------------------|
|  | LEATHER            |
|  | STONE (ELEVATIONS) |
|  | Marble             |
|  | DEMOLISHMENT WALLS |
|  | EXISTING WALLS     |
|  | PAINT (ELEVATIONS) |

**ABBREVIATIONS:**

|        |                       |          |                   |
|--------|-----------------------|----------|-------------------|
| F.F.L. | FINISH FLOOR LEVEL    | T.O.R.L. | TOP OF RAILING    |
| T.O.P. | TOP OF PARAPET        | T.O.S.W. | TOP OF SIDEWALK   |
| T.O.W. | TOP OF WALL           | T.S.     | TOP OF SAND       |
| T.P.W. | TOP OF PLANTER WALL   | FD       | FLOOR DRAIN       |
| T.O.S. | TOP OF STRUCTURE SLAB | R.W.O.   | RAIN WATER OUTLET |
| T.O.L. | TOP OF SOIL           | O.T.S.   | OPEN TO SKY       |
| W.F.   | WATER FEATURE         |          |                   |

**CALL OUTS**

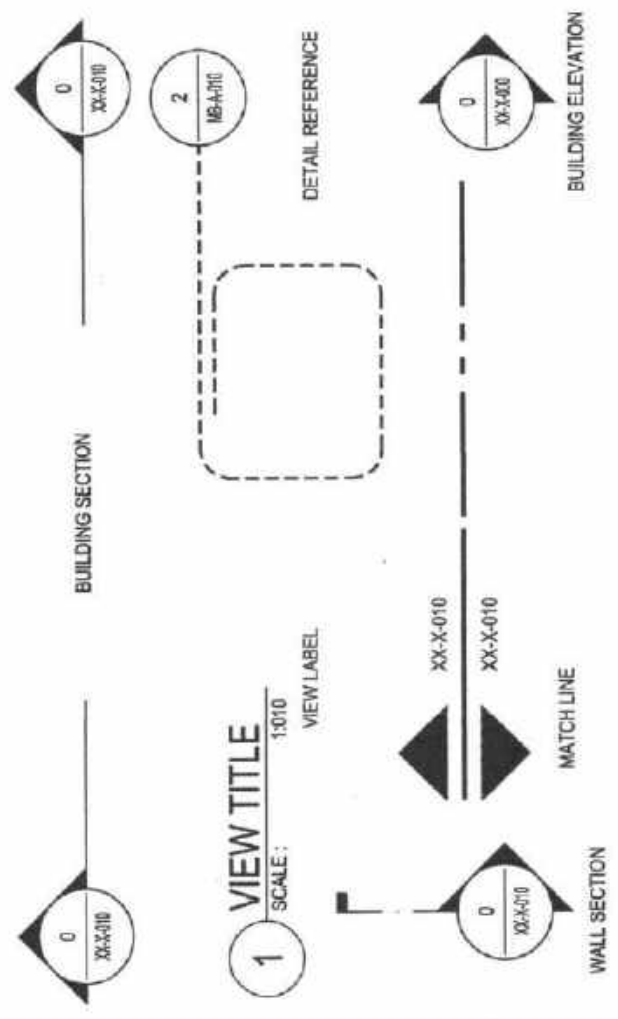

**ANNOTATIONS**

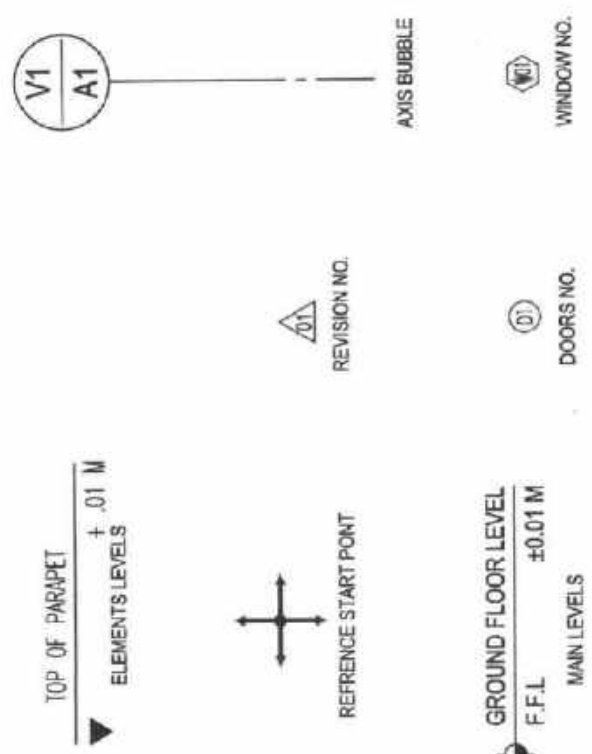

|   |  |                                 |   |   |   |                   |
|---|--|---------------------------------|---|---|---|-------------------|
| <br><b>OFFICE OF THE MINISTER</b><br>DEPARTMENT OF TRANSPORTATION AND COMMUNICATION | PROJECT & LOCATION<br>CONSTRUCTION OF RIVER LANDING AT LIBUNGAN, TORRETA, PIGCAWAYAN, SCA  | SHEET CONTENT<br>NOTES & SYMBOL | IN CHARGE:<br>JULLIE M. MALCAMPO<br>ARCHITECT | CHECKED AND REVIEWED BY:<br><br>ENGR. ASAPHIA D. ALJASSAR<br>ENGINEER | ALUMNUS BY:<br><br>ENGR. MARJORIE B. TERONCAL<br>ENGINEER | DATE: 01<br>AR-01 |
|   | <small>           THIS DRAWING IS THE PROPERTY OF THE ARCHITECT AND IS TO BE USED ONLY FOR THE PROJECT AND LOCATION SPECIFICALLY MENTIONED HEREIN. IT IS NOT TO BE REPRODUCED, COPIED, OR TRANSMITTED IN ANY FORM OR BY ANY MEANS, ELECTRONIC OR MECHANICAL, INCLUDING PHOTOCOPYING, RECORDING, OR BY ANY INFORMATION STORAGE AND RETRIEVAL SYSTEM, WITHOUT THE WRITTEN PERMISSION OF THE ARCHITECT. THE ARCHITECT ASSUMES NO LIABILITY FOR ANY DAMAGE OR INJURY TO PERSONS OR PROPERTY ARISING FROM THE USE OF THIS DRAWING.         </small> |                                 |   |   |   |                   |

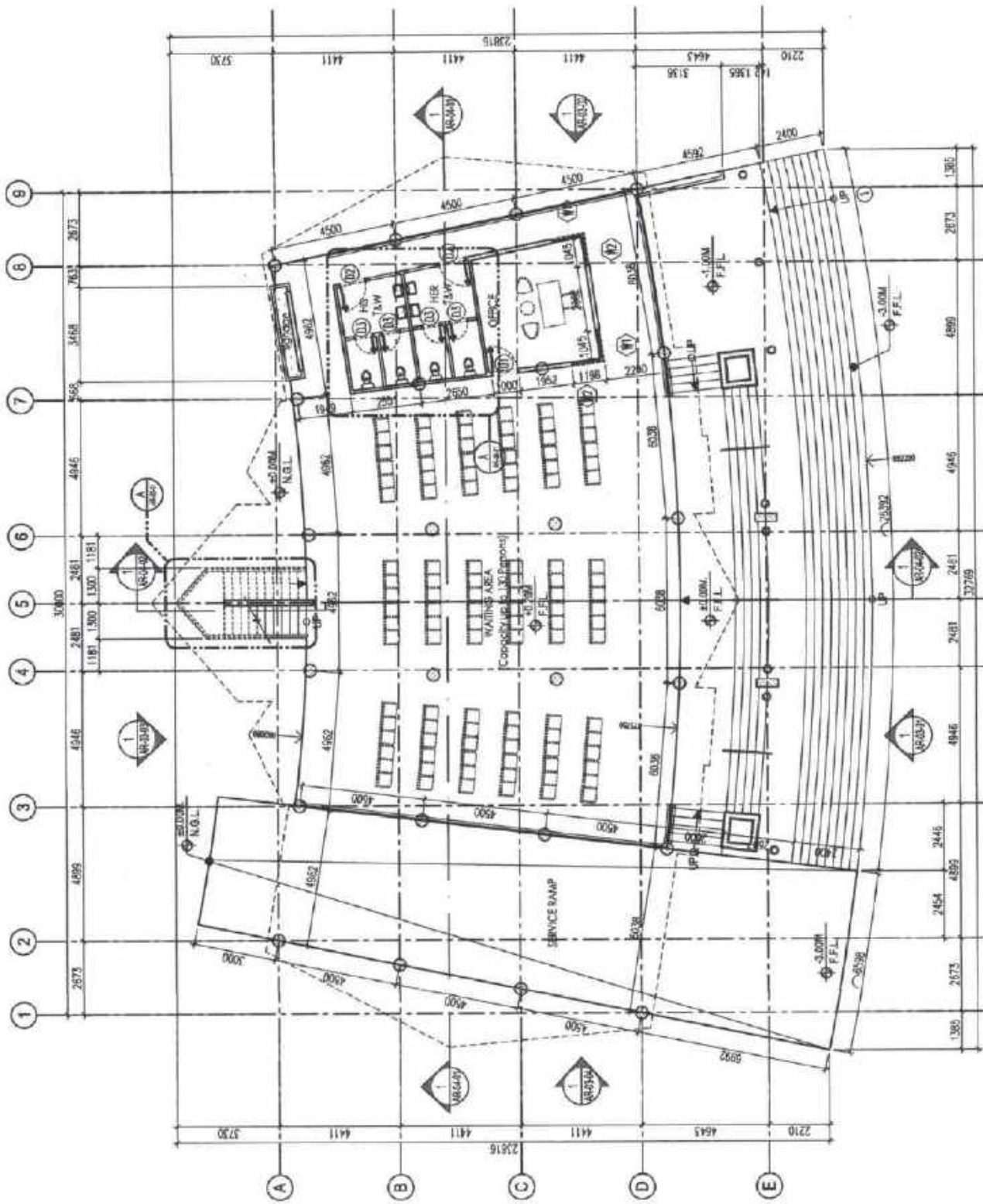

**A** GROUND FLOOR PLAN  
SCALE: 1:1000

|  |   |   |                                  |   |                   |                                  |
|--|---|---|----------------------------------|---|-------------------|----------------------------------|
|  <p>Republic of the Philippines<br/>MINISTRY OF TRANSPORTATION &amp; COMMUNICATION<br/><b>OFFICE OF THE MINISTER</b><br/>BALARA<br/>COTABATO CITY</p> | <p>DESIGNED AND REVIEWED BY:<br/><i>[Signature]</i><br/>ENGR. ASAPH A. ALANGSAR<br/>ENR-02/01</p> | <p>APPROVED BY:<br/><i>[Signature]</i><br/>JULIE M. MALDONADO<br/>ARCHITECT</p> | <p>REVISIONS:<br/>1. [Blank]</p> | <p>PROJECT TITLE:<br/>CONSTRUCTION OF<br/>RIVER LANDING<br/>AT LIBUNGAN, TORRETA, PIGGAWAYAN,<br/>SGA</p> | <p>FLOOR PLAN</p> | <p>PROJECT NO.:<br/>AR-02/01</p> |
|--|---|---|----------------------------------|---|-------------------|----------------------------------|

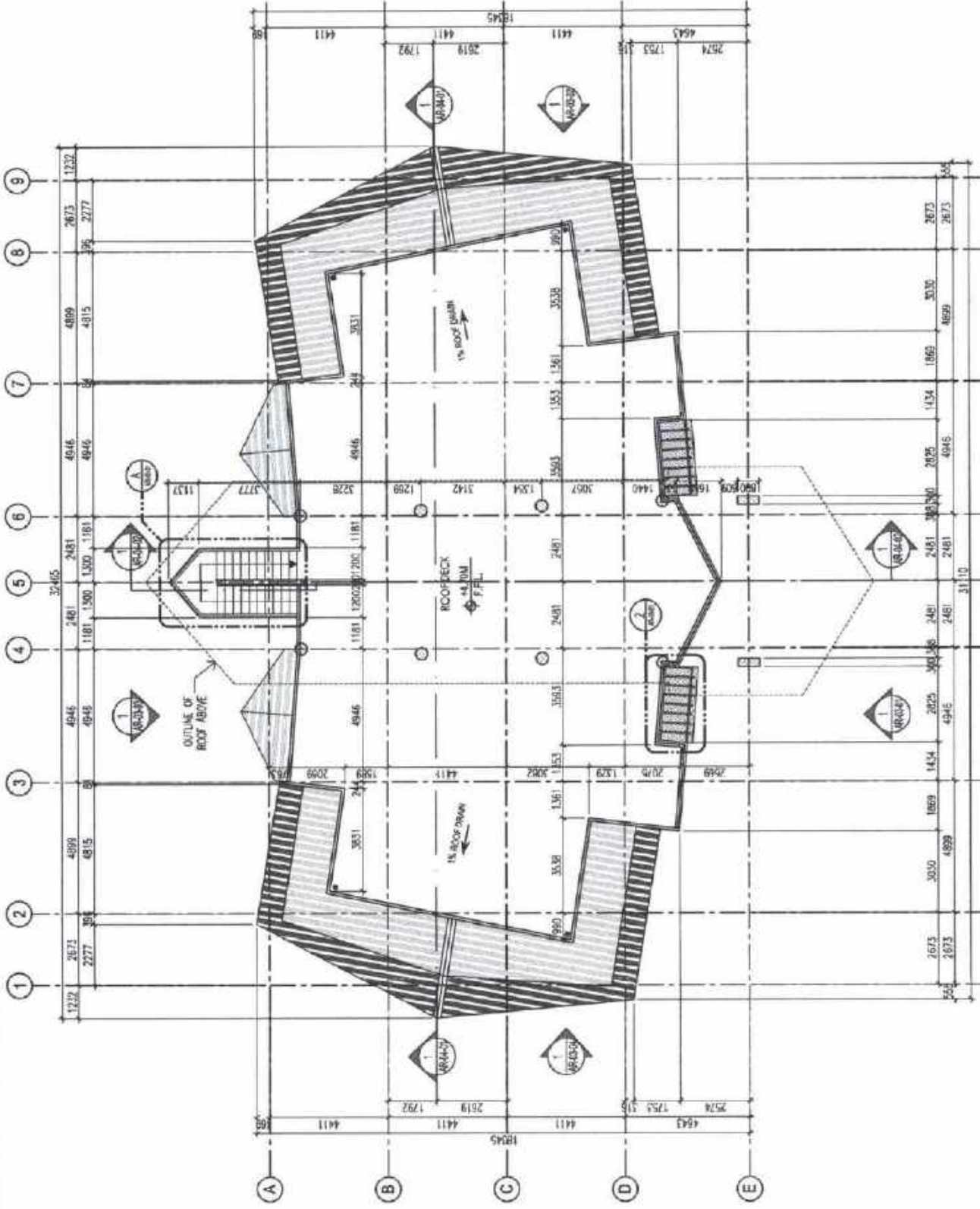

**A** ROOF DECK PLAN  
SCALE: 1:150M

|  |  |                                      |  |  |  |
|--|--|--------------------------------------|--|--|--|
| <p>OFFICE OF THE MINISTER<br/>DEPARTMENT OF TRANSPORTATION &amp; COMMUNICATION<br/>COTABATO CITY</p> | <p>PROJECT &amp; LOCATION:<br/>CONSTRUCTION OF<br/>RIVER LANDING<br/>AT LIBUNGAN, TORRETA, PIGCAWAYAN,<br/>SGA</p> | <p>SHEET CONTENT:<br/>FLOOR PLAN</p> | <p>REVISIONS:<br/>NO.   DATE   DESCRIPTION</p> | <p>DESIGNED BY: PAUL M. MALUMALO<br/>ARCHITECT</p> <p>CHECKED AND RECEIVED BY: ENGR. ASHRAH D. ALANGSAR<br/>ENGINEER</p> | <p>DATE: 01/14/18</p> <p>DRAWN BY: ENGR. ASHRAH D. ALANGSAR<br/>ENGINEER</p> <p>PROJECT NO.: AR-02<br/>SHEET NO.: 02</p> |
|--|--|--------------------------------------|--|--|--|



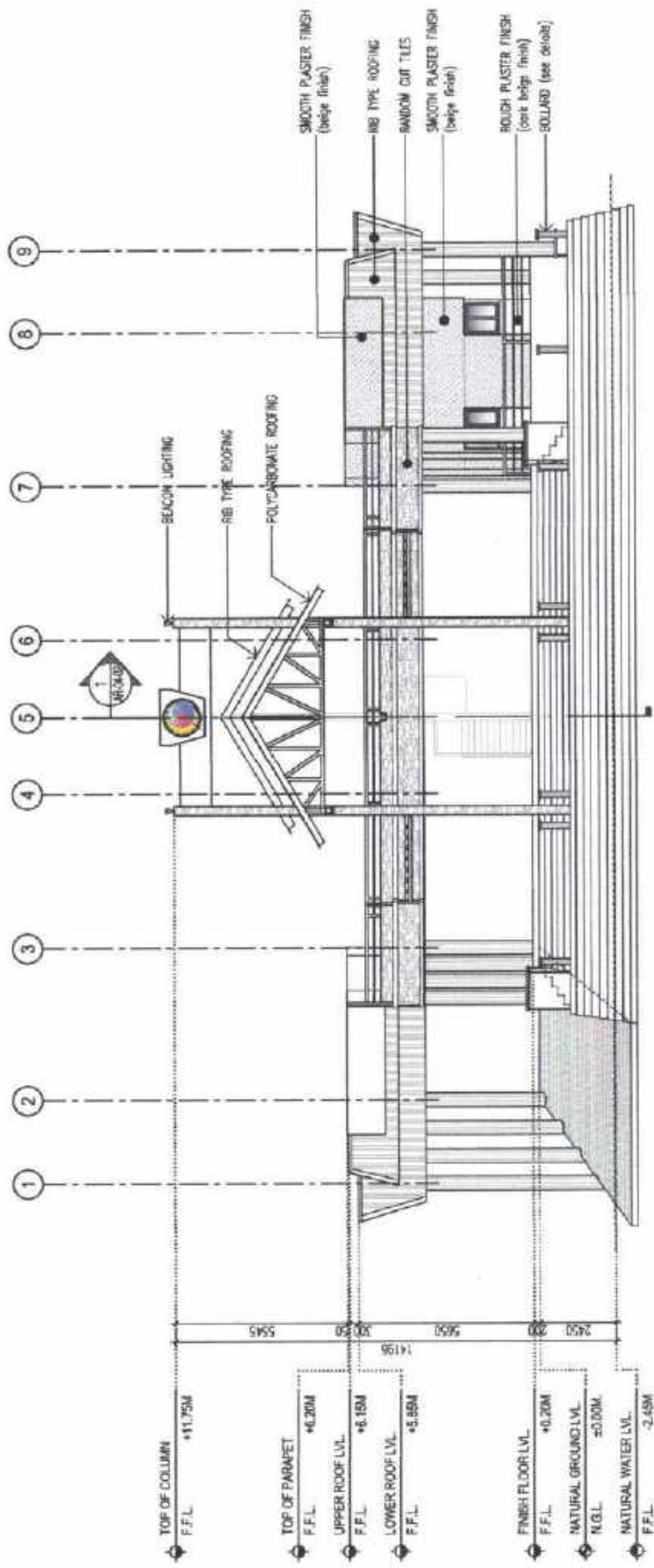

1 FRONT ELEVATION  
SCALE 1:150M

|  |  |  |   |   |   |   |   |
|--|--|--|---|---|---|---|---|
|  <p>Republic of the Philippines<br/>MINISTRY OF TRANSPORTATION &amp; COMMUNICATION<br/><b>OFFICE OF THE MINISTER</b><br/>BARANGAY COTABATO CITY</p> | <p>PROJECT &amp; LOCATION<br/><b>CONSTRUCTION OF<br/>RIVER LANDING<br/>AT LIBUNGAN, TORRETA, PIGCAWAYAN,<br/>SGA</b></p> | <p>SHEET CONCRETE<br/><b>ELEVATION</b></p> | <p>DATE: 08/08/2024<br/>DRAWN BY:  ARNEL M. ALJASSAF<br/>CHECKED AND REVIEWED BY:  ENGR. ARNEL M. ALJASSAF<br/>DATE: 08/08/2024</p> | <p>DATE: 08/08/2024<br/>DRAWN BY:  ENGR. ARNEL M. ALJASSAF<br/>CHECKED AND REVIEWED BY:  ENGR. ARNEL M. ALJASSAF<br/>DATE: 08/08/2024</p> | <p>DATE: 08/08/2024<br/>DRAWN BY:  ENGR. ARNEL M. ALJASSAF<br/>CHECKED AND REVIEWED BY:  ENGR. ARNEL M. ALJASSAF<br/>DATE: 08/08/2024</p> | <p>DATE: 08/08/2024<br/>DRAWN BY:  ENGR. ARNEL M. ALJASSAF<br/>CHECKED AND REVIEWED BY:  ENGR. ARNEL M. ALJASSAF<br/>DATE: 08/08/2024</p> | <p>DATE: 08/08/2024<br/>DRAWN BY:  ENGR. ARNEL M. ALJASSAF<br/>CHECKED AND REVIEWED BY:  ENGR. ARNEL M. ALJASSAF<br/>DATE: 08/08/2024</p> |
|--|--|--|---|---|---|---|---|

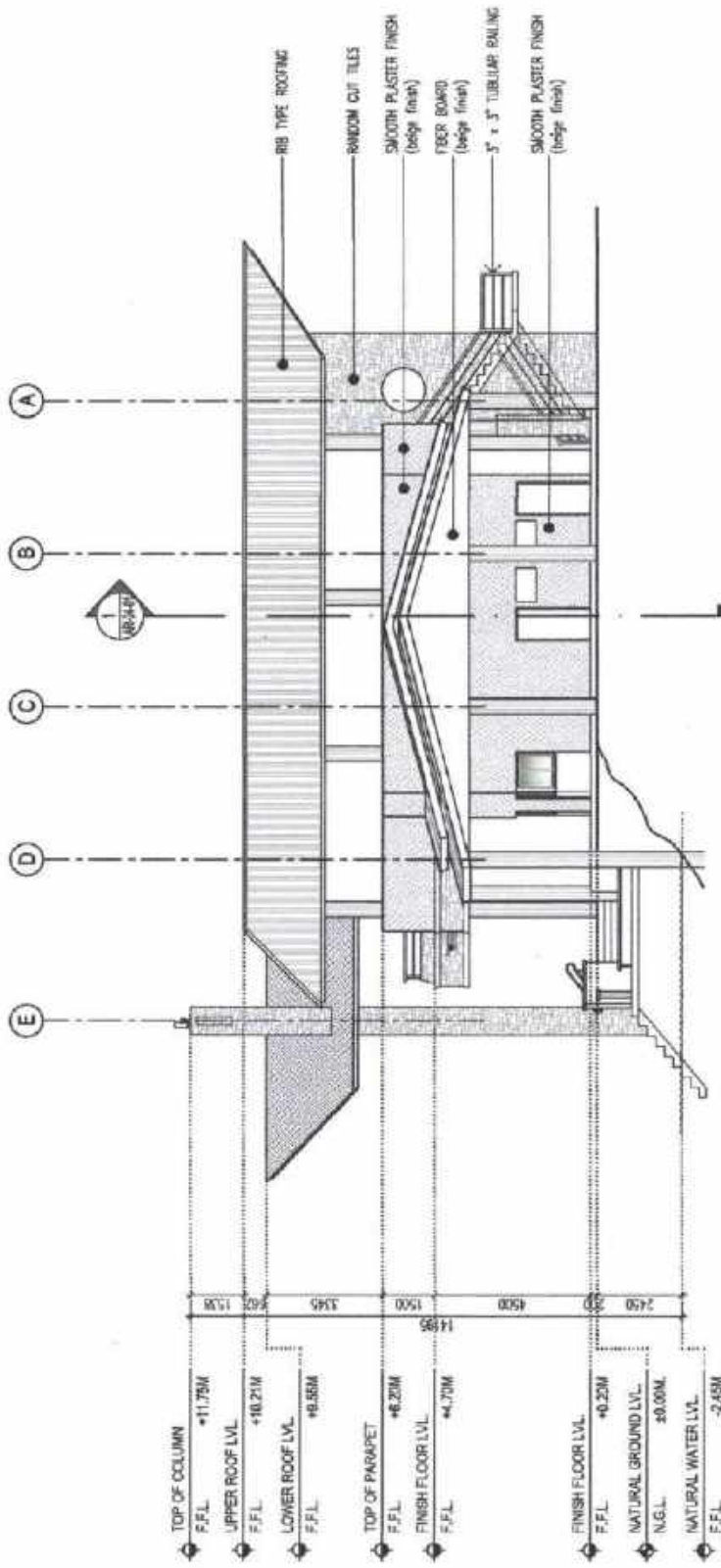

1 RIGHT SIDE ELEVATION  
SCALE: 1:150M



Department of the Philippines  
MINISTRY OF TRANSPORTATION & COMMUNICATION  
**OFFICE OF THE MINISTER**  
Pasay City

PROJECT & LOCATION:  
CONSTRUCTION OF  
RIVER LANDING  
AT LIBUNGAN, TORRETA, PIGCAYAWAN,  
SGA

SHEET CONTENT:  
ELEVATION

FOR MORE DETAILS REFER TO THE  
Design and Construction of the River Landing at Libungan, Piggawayan, SGA, is the responsibility of the Architect. The Architect shall be held responsible for the design, construction and completion of the project. The Architect shall be held responsible for the design, construction and completion of the project. The Architect shall be held responsible for the design, construction and completion of the project.

DESIGNED BY:  
SHEILA M. MALOMALO  
ARCHITECT

CHECKED AND REVIEWED BY:  
EMER ASORIANO, A. LAUSAR  
PLANNER III



DATE: 02/15/2024  
DRAWN BY:  
ENGR. JERON B. SIMSAL  
PLANNER V

SHEET NO.  
AR-03  
02

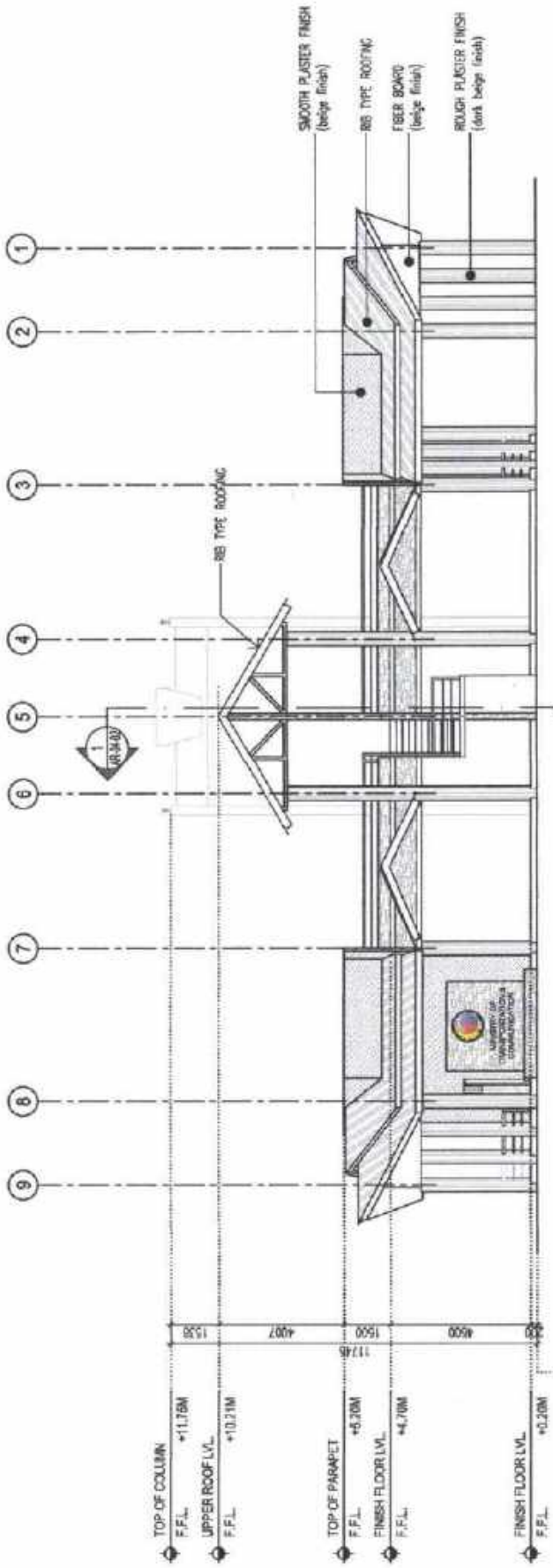



1 REAR ELEVATION  
SCALE 1:150M

|  |   |  |                         |  |  |   |  |
|--|---|--|-------------------------|--|--|---|--|
|  | <p>PROJECT &amp; LOCATION<br/><b>CONSTRUCTION OF<br/>RIVER LANDING<br/>AT LIBUNGAN, TORRETA, PIGCAWAYAN,<br/>SGA.</b></p> | <p>SHEET DESIGN<br/><b>ELEVATION</b></p> | <p>DATE: 05/11/2023</p> | <p>DESIGNED BY:<br/><br/>ARCHITECT</p> | <p>CHECKED AND REVISIONS:<br/><br/>ENGINEER</p> | <p>SUBMITTED BY:<br/><br/>ENGINEER</p> | <p>SHEET NO.<br/><b>AR-03</b><br/>03</p> |
|--|---|--|-------------------------|--|--|---|--|

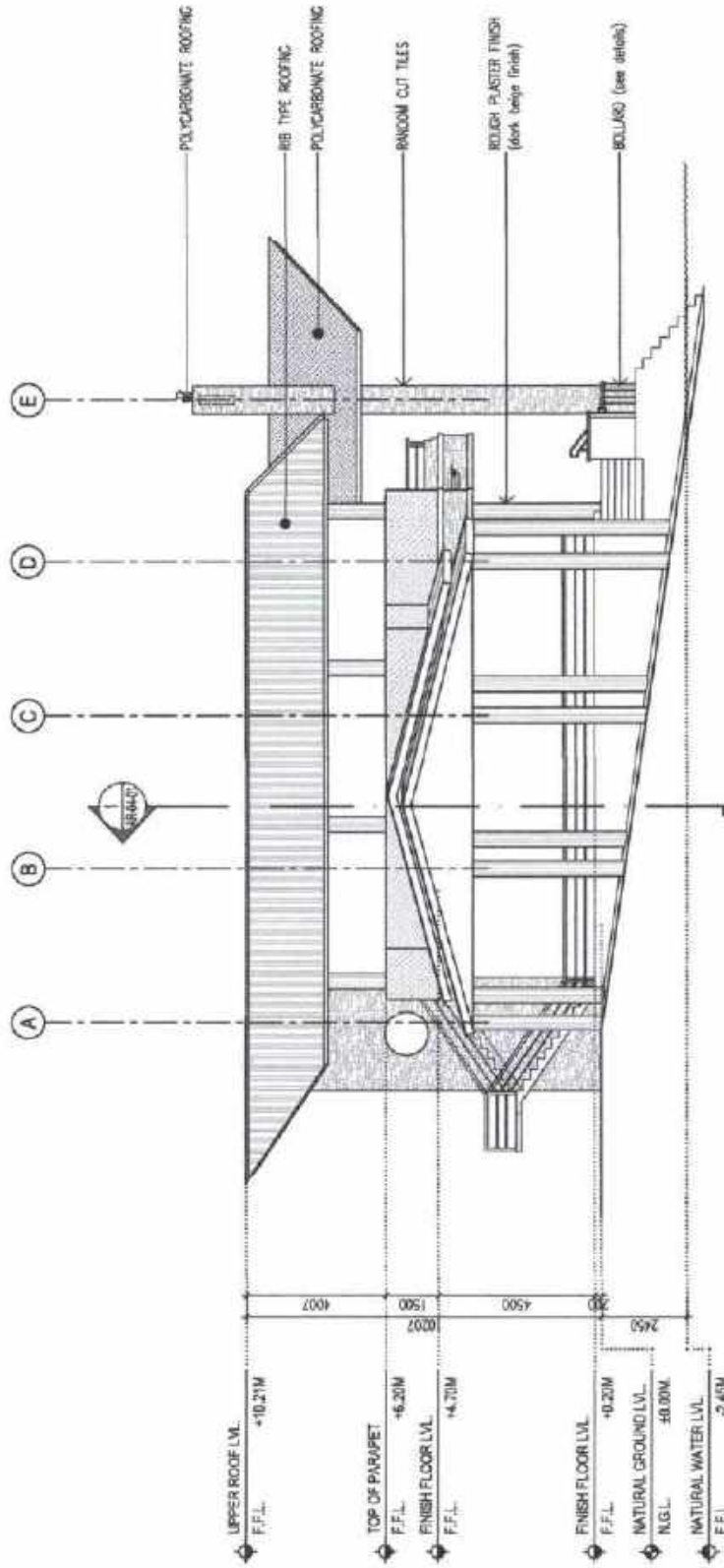

1 LEFT SIDE ELEVATION  
SCALE: 1/150M

|   |  |  |
|---|--|--|
|   | <p>PROJECT &amp; LOCATION<br/><b>CONSTRUCTION OF RIVER LANDING AT LIBUNGAN, TORRETA, PIGCAWAYAN, SGA</b></p> | <p>DATE OF SHEET<br/><b>AR-03</b><br/><b>04</b></p>                                |
| <p>OFFICE OF THE MINISTER<br/>BUREAU OF PUBLIC WORKS AND CONSTRUCTION<br/>DEPARTMENT OF TRANSPORTATION AND COMMUNICATIONS<br/>PHILIPPINES</p> | <p>DESIGNED BY:<br/><i>[Signature]</i><br/>ENGR. ASHFITHA D. ALJAGGAR</p>                                    | <p>CHECKED AND REVIEWED BY:<br/><i>[Signature]</i><br/>ENGR. CARLOS B. ANDRADA</p> |
| <p>PROJECT NO. 1</p>  | <p>DATE OF SHEET</p>   | <p>SCALE</p>   |
| <p>PROJECT NO. 1</p>  | <p>DATE OF SHEET</p>   | <p>SCALE</p>   |

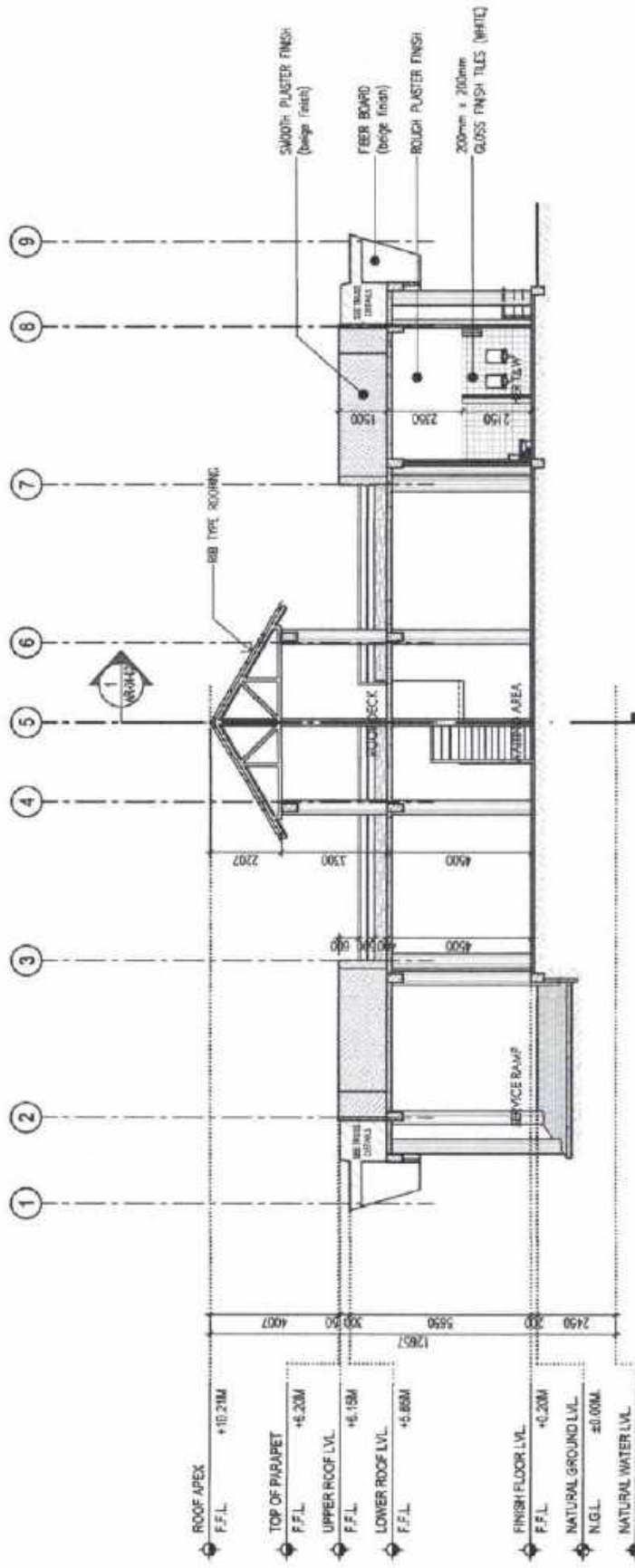

1 SECTION A  
SCALE: 1:150M



Republic of the Philippines  
 DEPARTMENT OF TRANSPORTATION & COMMUNICATION  
**OFFICE OF THE MINISTER**  
 PASAY CITY

PROJECT LOCATION  
**CONSTRUCTION OF  
 RIVER LANDING  
 AT LIBUNGAN, TORRETA, PIGCAYAYAN,  
 SGA**

SHEET CONTENT  
**SECTION**

PLANNING, ARCHITECTURE, ENGINEERING  
 Design and construction services for the proposed project. The design is based on the information provided by the client and is subject to change without notice. The design is for general reference only and does not constitute a contract. The design is based on the information provided by the client and is subject to change without notice. The design is for general reference only and does not constitute a contract.

ARCHITECT  
**DR. JUAN M. DELA CRUZ**

CHECKED AND REVIEWED BY  
**ENGR. ASHLEY D. ALANGAR**  
 PLANNING

DESIGNED BY  
**ENGR. MARGARET B. LUCANAL**  
 PLANNING

SHEET NO.  
**AR-04  
 01**

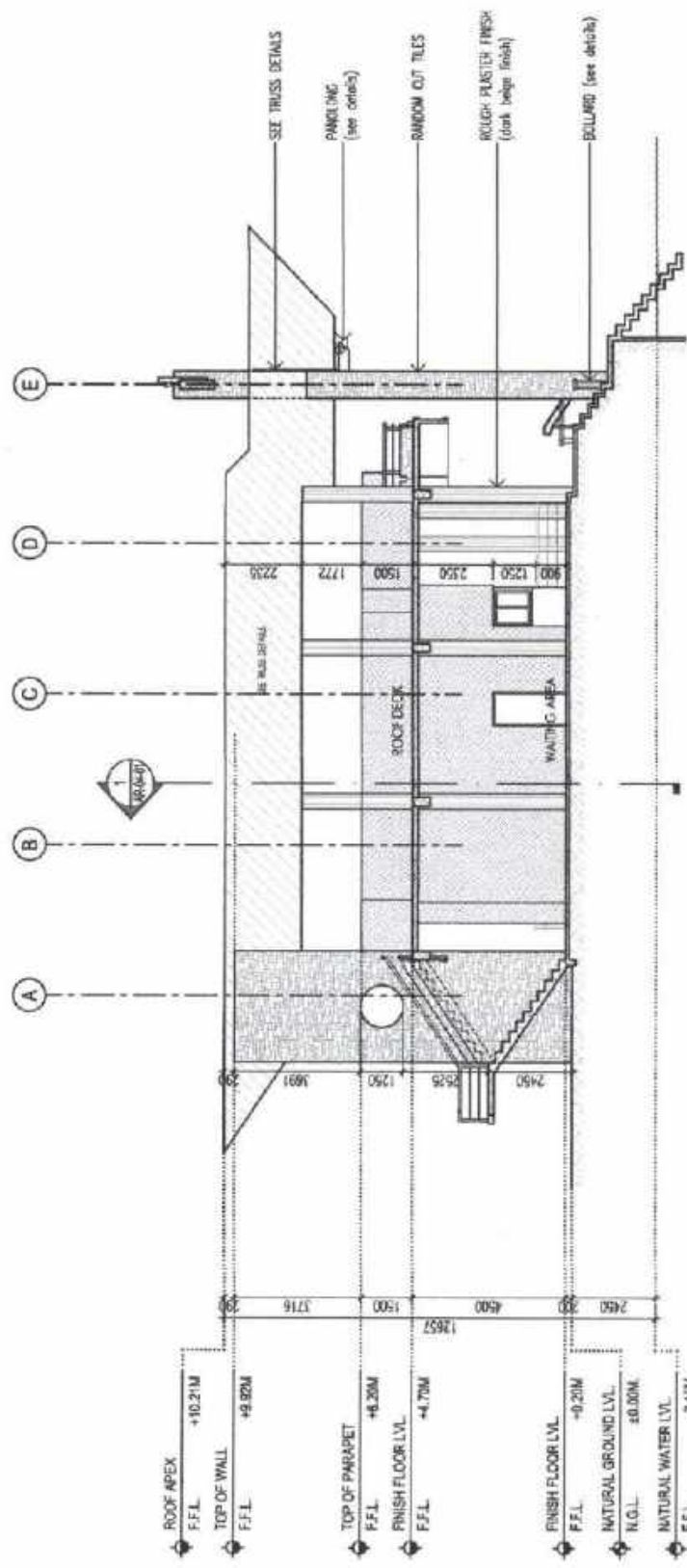

1 SECTION B  
SCALE: 1:150M

|  |  |   |   |  |   |  |                         |
|--|--|---|---|--|---|--|-------------------------|
|  | <p>Republic of the Philippines<br/>         DEPARTMENT OF TRANSPORTATION AND COMMUNICATION<br/> <b>OFFICE OF THE MINISTER</b><br/>         RAJAHMUNDRAN<br/>         COTABATO CITY</p> | <p>PROJECT &amp; LOCATION:<br/> <b>CONSTRUCTION OF<br/>         RIVER LANDING<br/>         AT LIBUNGAN, TORRETA, PIGGAWAYAN,<br/>         SGA</b></p> | <p>SHEET CONTENT:<br/> <b>SECTION</b></p> | <p>DATE: 02/11/2024<br/>         PROJECT NO: AR-04<br/>         SHEET NO: 02</p> | <p>DESIGNED AND REVISED BY:<br/> <br/> <b>M. D. AL-JASGAR</b><br/>         ENGINEER</p> | <p>CHECKED BY:<br/> <br/> <b>S. MAITTO</b><br/>         ENGINEER</p> | <p>DATE: 02/11/2024</p> |
|--|--|---|---|--|---|--|-------------------------|

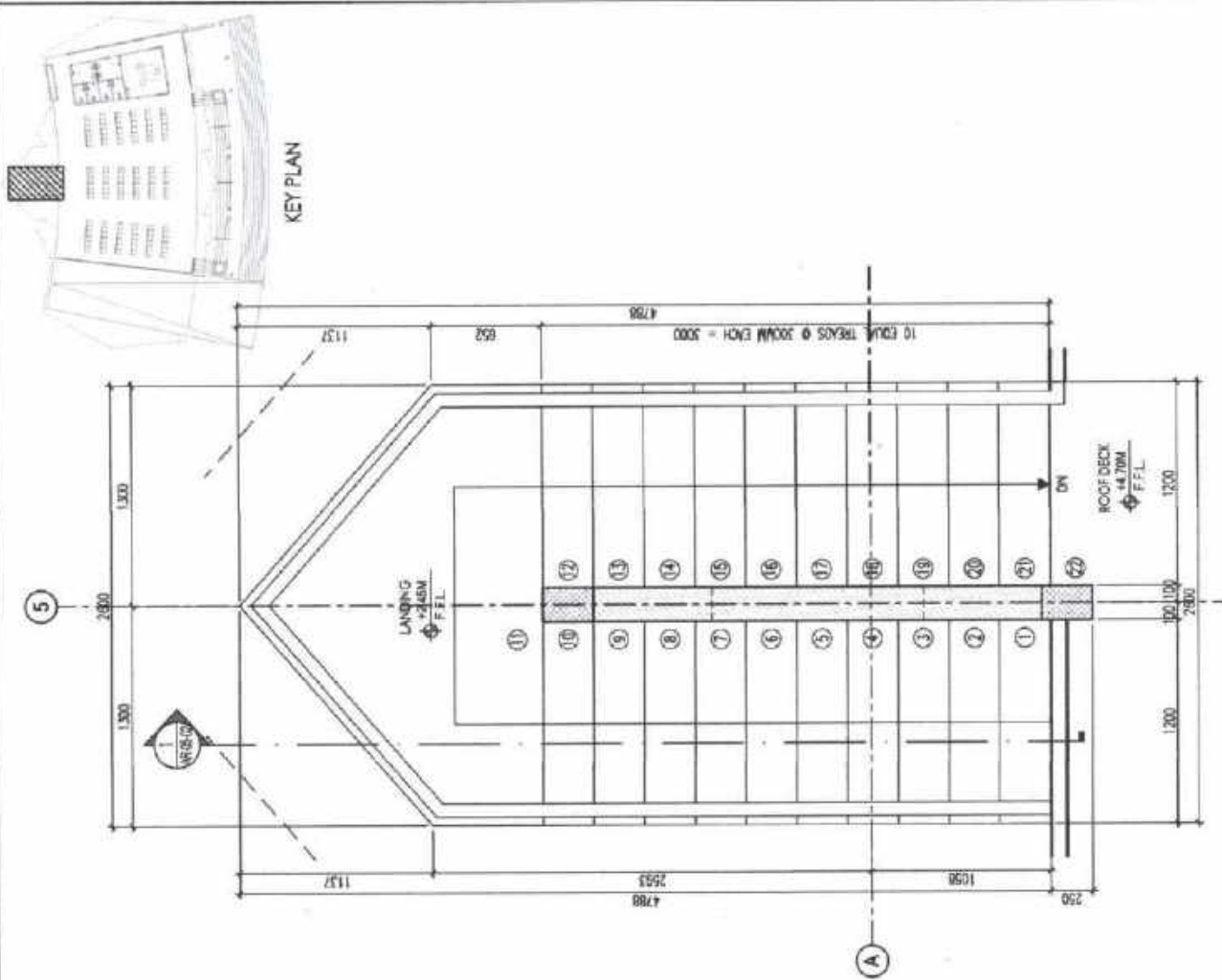

**B PLAN @ ROOF DECK**  
SCALE: 1:300

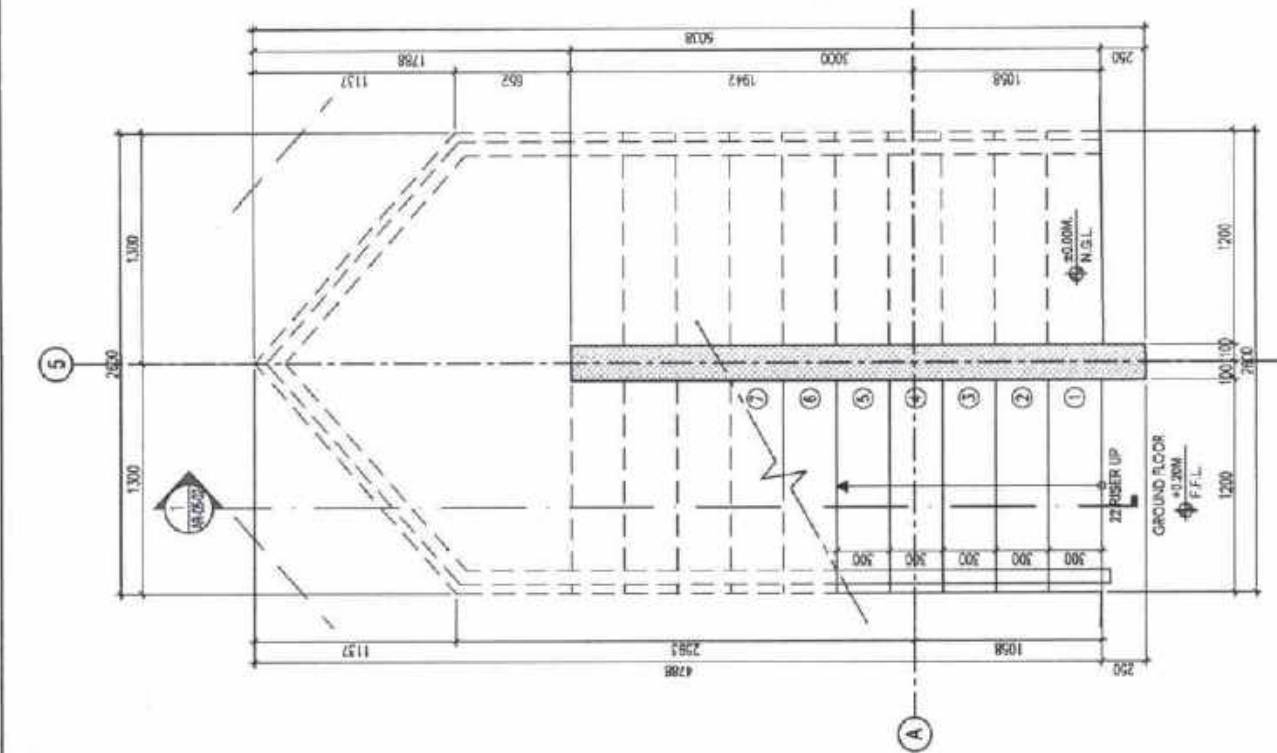

**A PLAN @ GROUND FLOOR**  
SCALE: 1:300

|  |   |  |  |
|--|---|--|--|
|  | PROJECT & LOCATION:<br><b>CONSTRUCTION OF<br/>RIVER LANDING<br/>AT LIBUNGAN, TORRETA, PIGCAWAYAN,<br/>SGA</b> | SHEET CONTENT:<br><b>STAIR DETAILS</b>   | PROJECT NO:<br><b>AR-05<br/>01</b>   |
|  | SUBMITTED BY:<br><br><b>ENGINEER RODERICK B. BANTAYAN</b><br>REGISTERED PROFESSIONAL ENGINEER                 | CHECKED AND APPROVED BY:<br><br><b>ENGR. ARIFHA D. ALJAGAR</b><br>REGISTERED PROFESSIONAL ENGINEER | PREPARED BY:<br><br><b>ENGR. ARIFHA D. ALJAGAR</b><br>REGISTERED PROFESSIONAL ENGINEER |



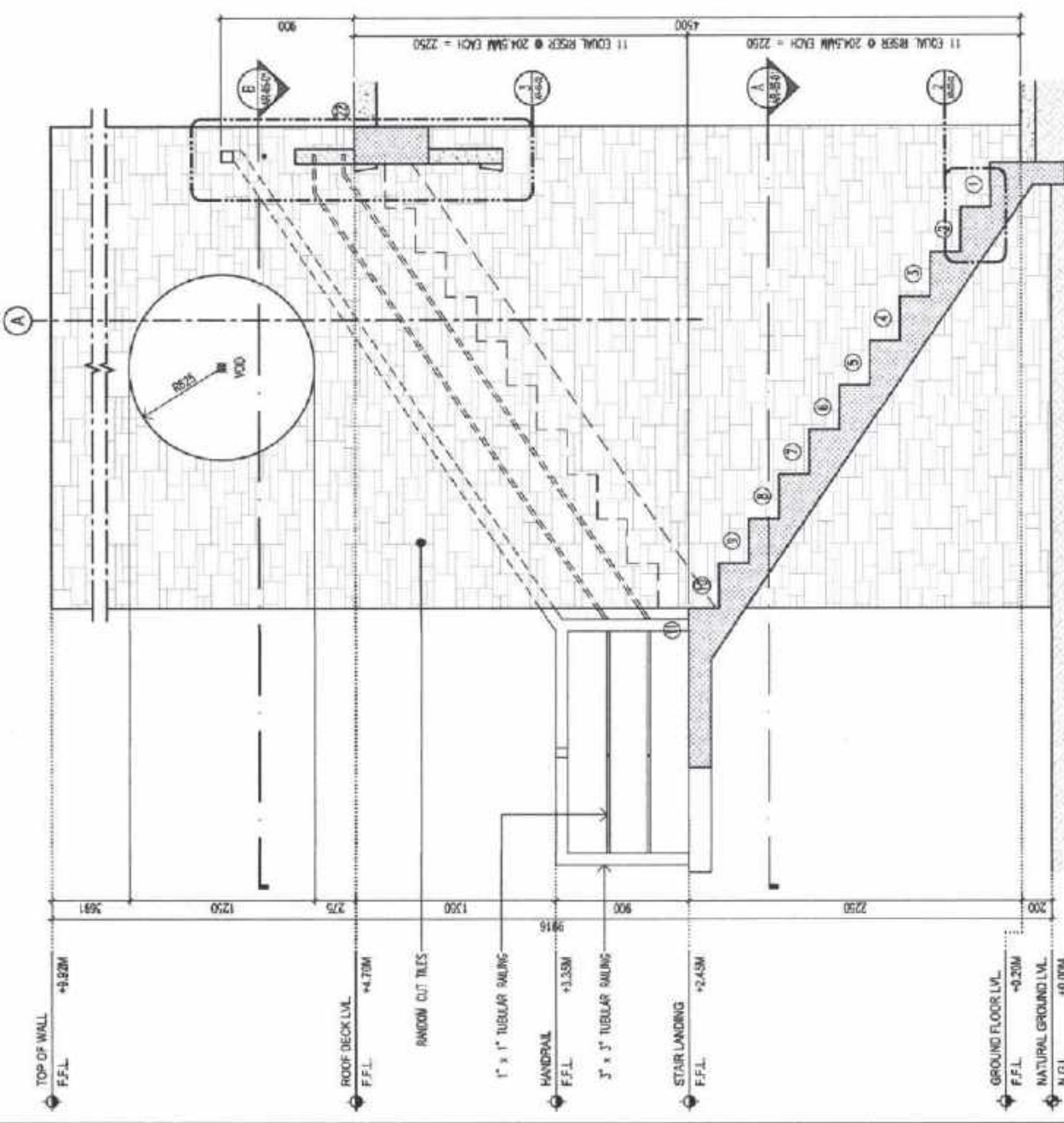

**1** SECTION DETAILS  
SCALE: 1:30M

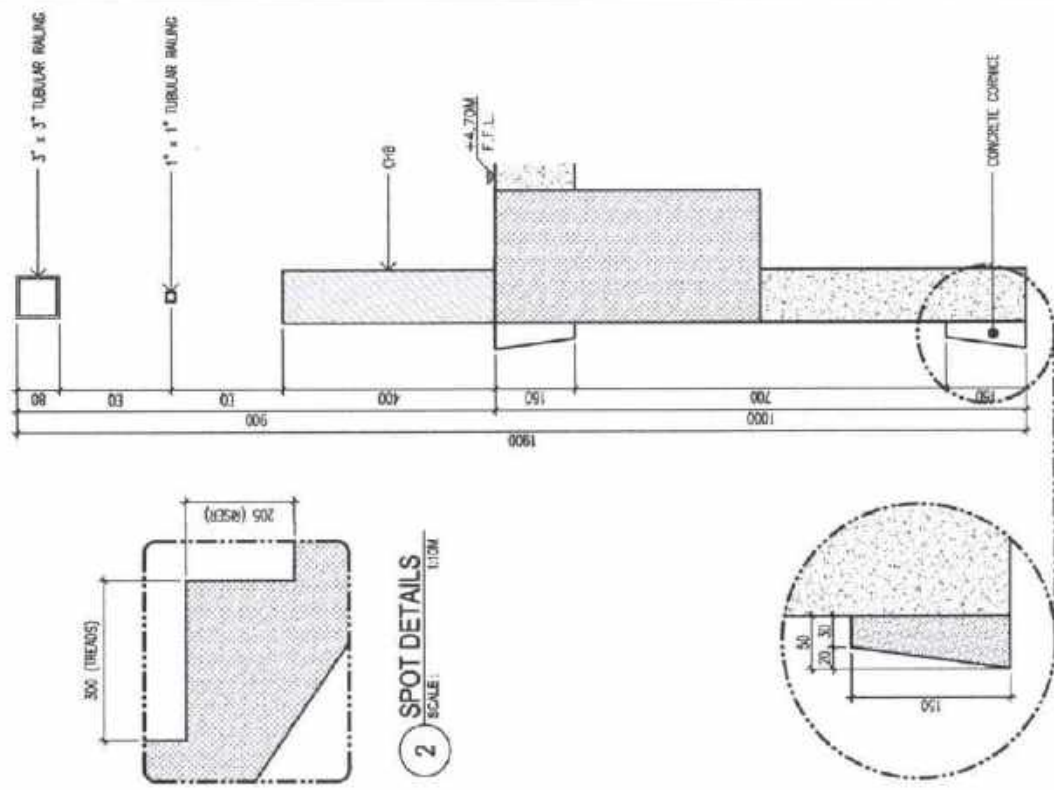

**2** SPOT DETAILS  
SCALE: 1:150M

**3** SPOT DETAILS  
SCALE: 1:30M



Republic of the Philippines  
MINISTRY OF TRANSPORTATION & COMMUNICATION  
**OFFICE OF THE MINISTER**  
BARUW  
COTABATO CITY

PROJECT LOCATION  
CONSTRUCTION OF  
RIVER LANDING  
AT LIBUNGAN, TORRETA, PIGCAWAYAN,  
SGA

SHEET CONTENTS  
STAIR DETAILS

IN THE EVENT OF A DISCREPANCY BETWEEN THE DRAWING AND THE SPECIFICATIONS, THE SPECIFICATIONS SHALL PREVAIL.  
The Engineer shall be responsible for the accuracy of the drawings and specifications. The Engineer shall not be held liable for any errors or omissions in the drawings and specifications.

REVISIONS BY: [Signature]  
PROJECT NO. [Number]

CHECKED AND APPROVED BY: [Signature]  
ENGINEER [Name]

DESIGNED BY: [Signature]  
ENGINEER [Name]

SHEET NO. AR-05  
02



KEY PLAN

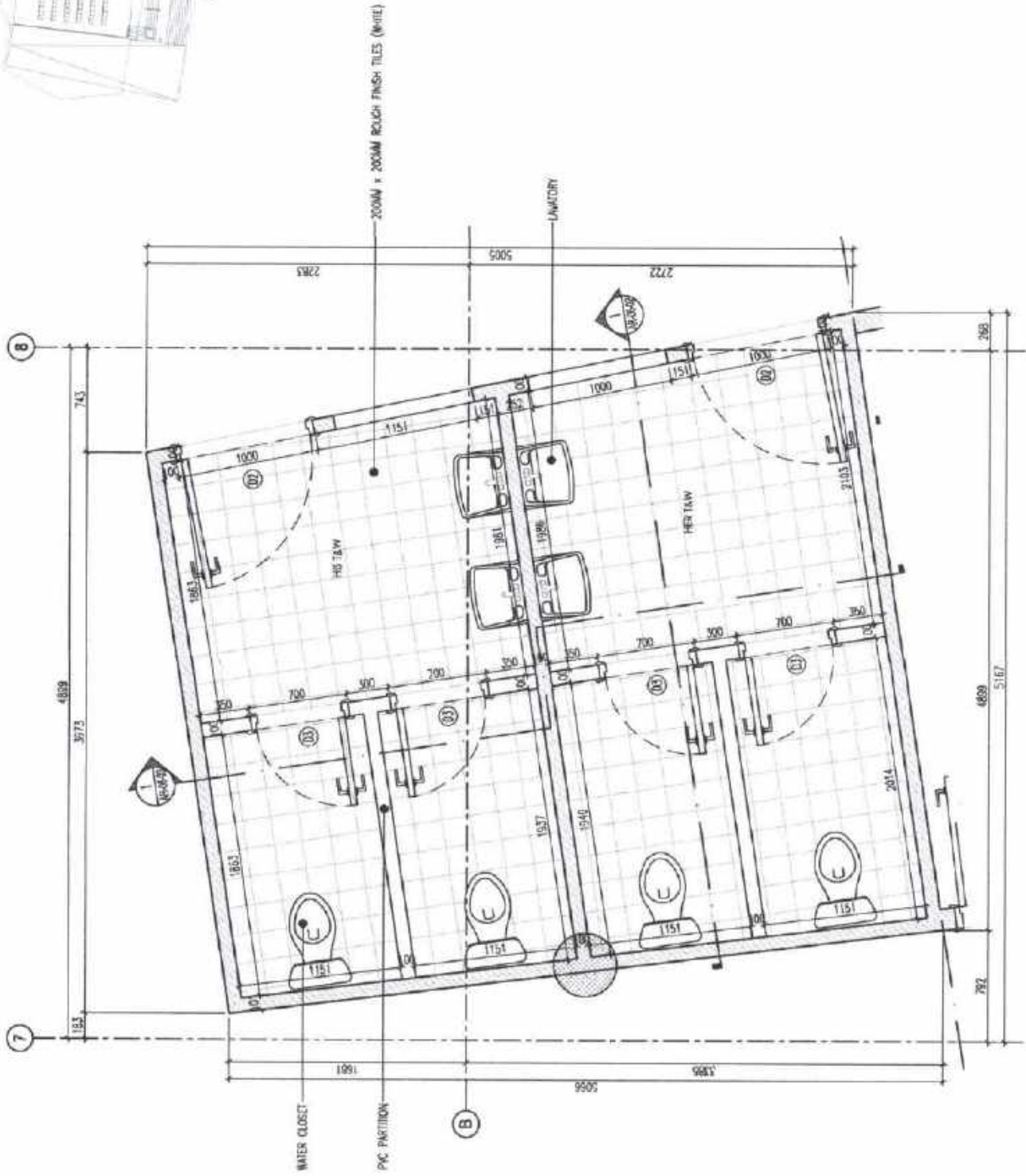

1 PARTIAL PLAN DETAILS  
SCALE: 1:500

|   |  |  |  |  |  |                                   |
|---|--|--|--|--|--|-----------------------------------|
| <p>MINISTRY OF TRANSPORTATION &amp; COMMUNICATION<br/>OFFICE OF THE MINISTER<br/>BAURUM<br/>COTABATO CITY</p> | <p>PROJECT &amp; LOCATION:<br/>CONSTRUCTION OF<br/>RIVER LANDING<br/>AT LIBUNGAN, TORRETA, PIGCAWAYAN,<br/>SGA</p> | <p>SHEET CONTENT:<br/>TOILET DETAILS</p> | <p>IN CASE APPROVAL IS REQUIRED BY:<br/>Design and Approval by: [Signature]<br/>Checked by: [Signature]<br/>Approved by: [Signature]</p> | <p>DESIGNED BY:<br/>[Signature]<br/>ENGR. ASPIHAN D. ALJASGAR<br/>REGISTERED PROFESSIONAL ENGINEER</p> | <p>CHECKED AND REVISIONS BY:<br/>[Signature]</p> | <p>SHEET NO.<br/>AR-06<br/>01</p> |
|---|--|--|--|--|--|-----------------------------------|

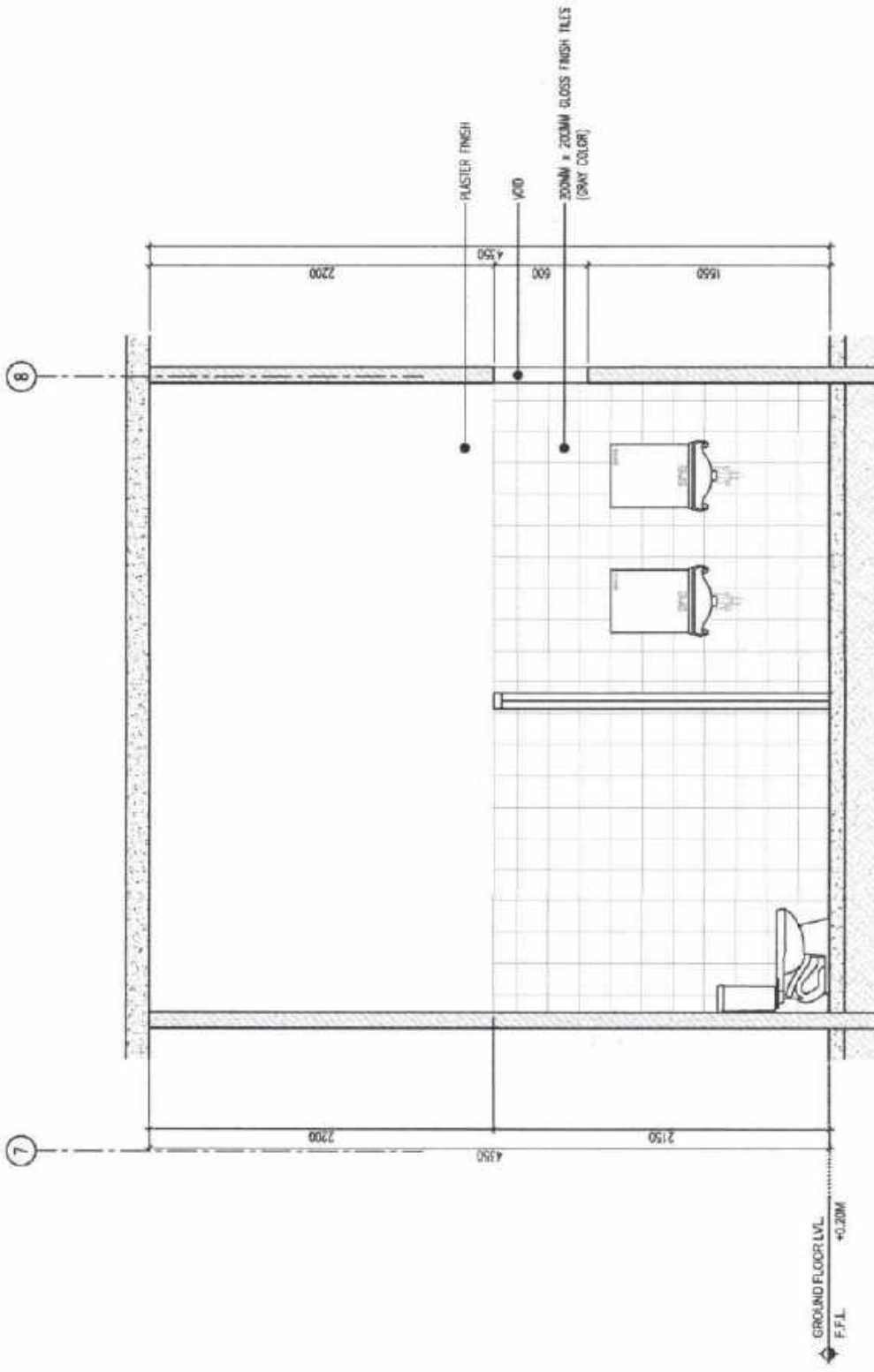

1 SECTION DETAILS  
SCALE: 1:30M

|  |   |   |  |   |   |  |  |                                   |
|--|---|---|--|---|---|--|--|-----------------------------------|
|  | <p>Republic of the Philippines<br/>MINISTRY OF TRANSPORTATION &amp; COMMUNICATION<br/><b>OFFICE OF THE MINISTER</b><br/>DO T &amp; C<br/>CORRADO CITY</p> | <p>PROJECT &amp; LOCATION<br/>CONSTRUCTION OF<br/>RIVER LANDING<br/>AT LIBUNGAN, TORRETA, PIGCAWAYAN,<br/>SGA</p> | <p>SHEET CONTENTS<br/>TOILET DETAILS</p> | <p>IN CASE OF DISCREPANCIES<br/>Change in Specifications and the Contract Documents shall be governed by the Contract Documents as the Contract Documents shall prevail in the event of any discrepancy between the Contract Documents and the Specifications. The Contractor shall be responsible for the accuracy of the Contract Documents and the Specifications. The Contractor shall be responsible for the accuracy of the Contract Documents and the Specifications. The Contractor shall be responsible for the accuracy of the Contract Documents and the Specifications.</p> | <p>APPROVED BY:<br/>JULIE M. WALTON<br/>ARCHITECT</p> | <p>CHECKED AND REVIEWED BY:<br/>ENGR. KRISTINA D. ALJASGAR<br/>REGISTERED ENGINEER</p> | <p>DATE: 02/15/2024<br/>DRAWN BY:<br/>ENGR. ANDREW B. BONGALAN<br/>REGISTERED ENGINEER</p> | <p>SHEET NO.<br/>AR-06<br/>02</p> |
|--|---|---|--|---|---|--|--|-----------------------------------|



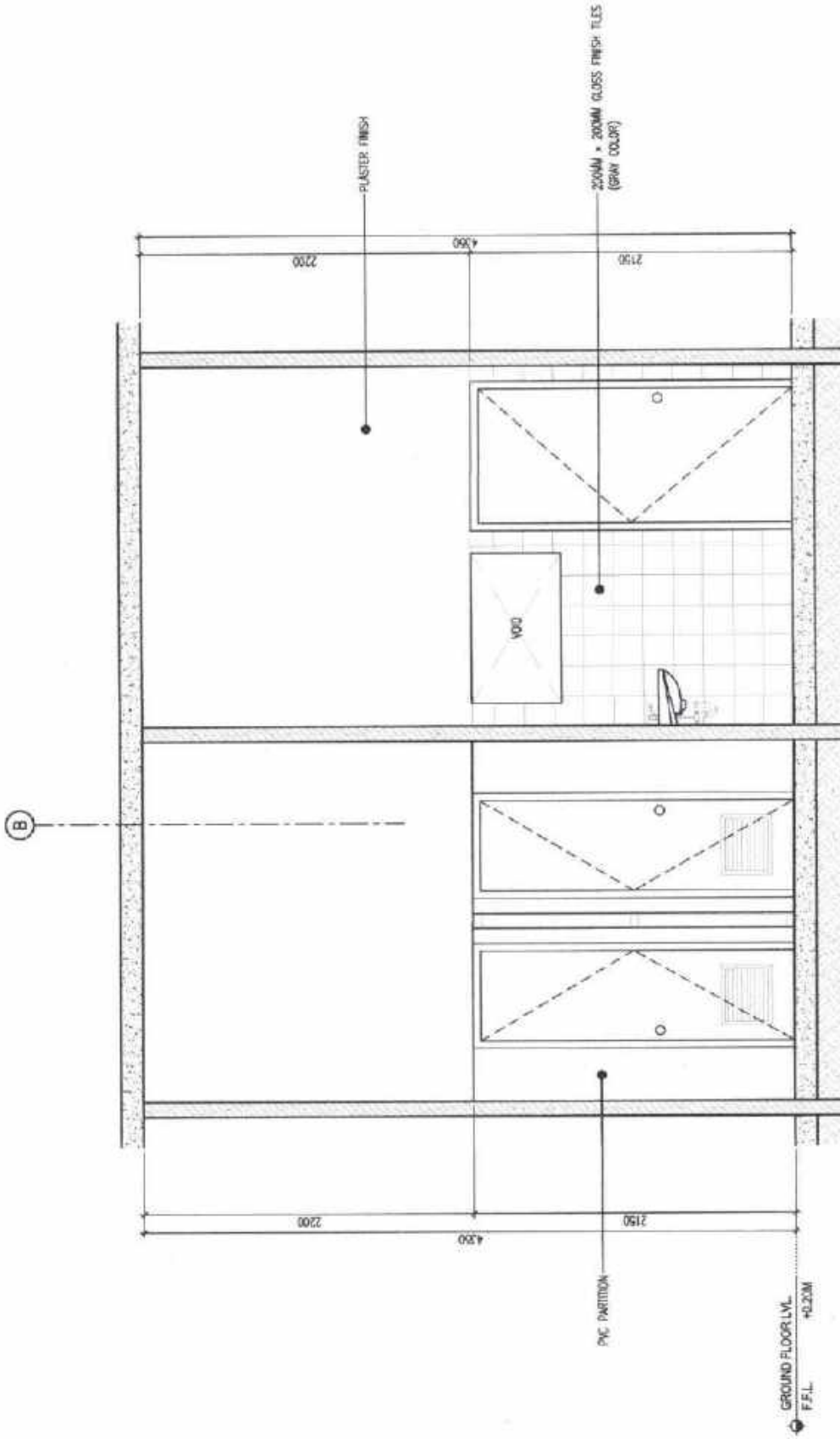

1 SECTION DETAILS  
SCALE 1:300

|  |  |   |  |  |   |  |
|--|--|---|--|--|---|--|
|  <p>REPUBLIC OF THE PHILIPPINES<br/>MINISTRY OF TRANSPORTATION &amp; COMMUNICATION<br/><b>OFFICE OF THE MINISTER</b><br/>BARANGAY COTABATO CITY</p> | <p>PROJECT &amp; LOCATION<br/><b>CONSTRUCTION OF<br/>RIVER LANDING<br/>AT LIBUNGAN, TORRETA, PIGCAYAWAN,<br/>SGA</b></p> | <p>SHEET CONTENT:<br/><b>TOILET DETAILS</b></p> | <p>DATE: 08/11/2023<br/>DRAWN BY: <b>JULIUS MALOMALO</b><br/>ARCHITECT I</p> | <p>CHECKED AND REVIEWED BY:<br/><b>EMER CASAR-HA, D. ALASGAR</b><br/>PROJECT III</p> | <p>SUBMITTED BY:<br/><b>ENGR. SAGORAN B. BERTOLINO</b><br/>ENR 001 10</p> | <p>SHEET NO.<br/><b>AR-06<br/>03</b></p> |
|--|--|---|--|--|---|--|

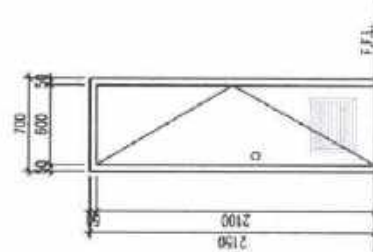
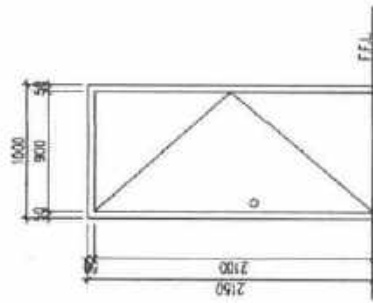
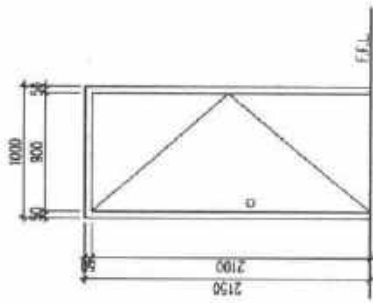

**D1**  
RECD. 1 SET

TYPE SOLID FLUSH DOOR  
(W/WHISH FINISH)  
LOCATION OFFICE

**D2**  
RECD. 2 SETS

TYPE PRE FABRICATED PVC DOOR  
LOCATION TOILET

**D3**  
RECD. 4 SETS

TYPE PRE FABRICATED PVC DOOR  
LOCATION TOILET

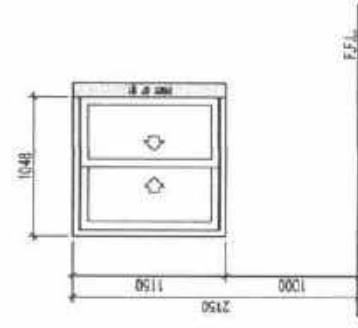
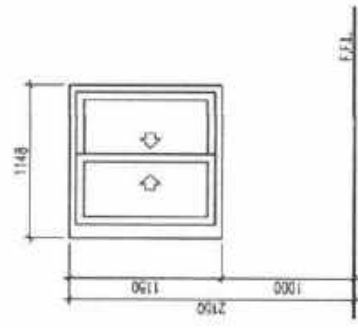

**W1**  
RECD. 2 SETS

TYPE SLIDING WINDOW  
ON ALUMINUM FRAME  
8mm THICK GREEN REFLECTIVE GLASS  
LOCATION OFFICE

**W2**  
RECD. 2 SETS

TYPE SLIDING WINDOW  
ON ALUMINUM FRAME  
8mm THICK GREEN REFLECTIVE GLASS  
LOCATION OFFICE



Republic of the Philippines  
MINISTRY OF TRANSPORTATION & COMMUNICATION  
**OFFICE OF THE MINISTER**  
DAVAO COTABATO CITY

PROJECT & LOCATION  
CONSTRUCTION OF  
RIVER LANDING  
AT LIBUNGAN, TORRETA, PIGCAYAWAN,  
SGA

WELL CONTACT  
DOORS & WINDOWS  
SCHEDULES

REMARKS BY:  
CHECKED AND REVISED BY:  
DESIGNED BY:  
ARCHITECT  
JALL V. TRICOMALLO  
ENGR. ASYUHA D. ALJONGGA  
INSPECTOR II  
ENGR. MACORDES B. MANSAL  
INSPECTOR IV

Scale 1:10  
**AR-07**  
01

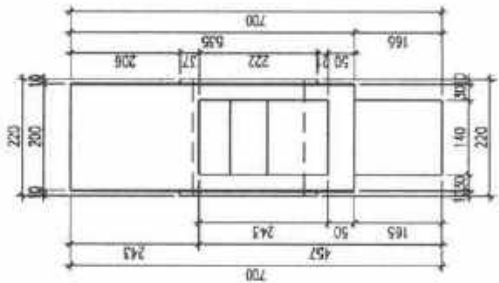

TOP VIEW

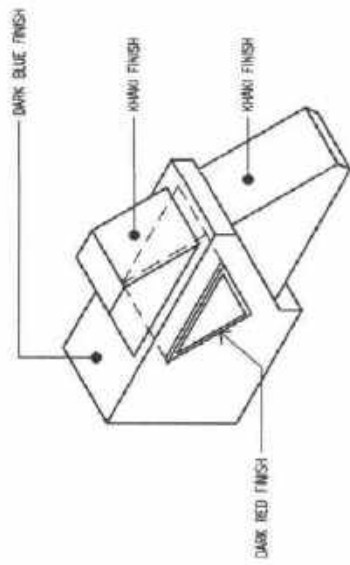

ISOMETRIC VIEW

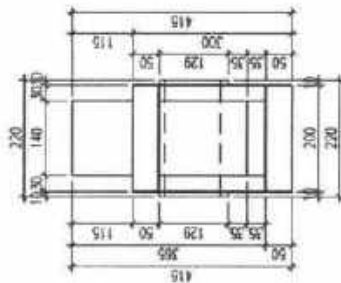

FRONT VIEW

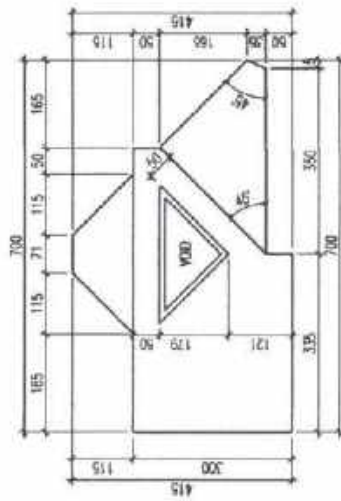

SIDE VIEW

1 PANOLONG DETAILS  
SCALE: 1:10M



2 LOGO DETAILS  
SCALE: 1:15M

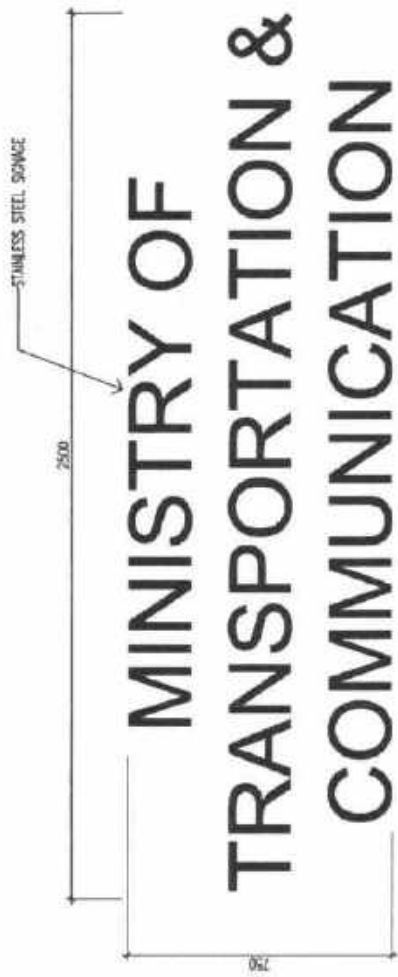

3 SIGNAGE DETAILS  
SCALE: 1:15M



Republic of the Philippines  
MINISTRY OF TRANSPORTATION & COMMUNICATION  
**OFFICE OF THE MINISTER**  
BARRAMI  
COTABATO CITY

PROJECT & LOCATION:  
CONSTRUCTION OF  
RIVER LANDING  
AT LIBUNGAN, TORRETA, PIGCAYAWAN,  
SGA

SHEET CONTENT:  
DETAILS

APPROVALS AND COMMENTS:  
Checked and Approved by:  
JALM M. MALONAL  
ARCHITECT

REVISIONS:  
NO. 01

DESIGNED BY:  
ENGR. ABIGAIL D. JAGGAR

DATE FILE:  
AR-08  
01

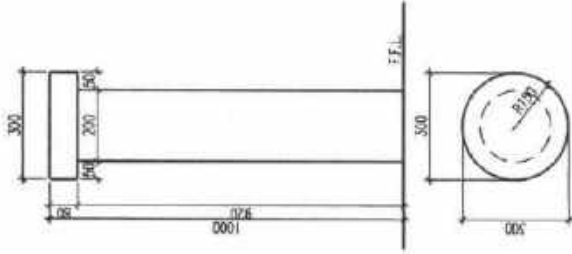

1 CONCRETE BOLLARD DETAILS  
SCALE: 1/15M

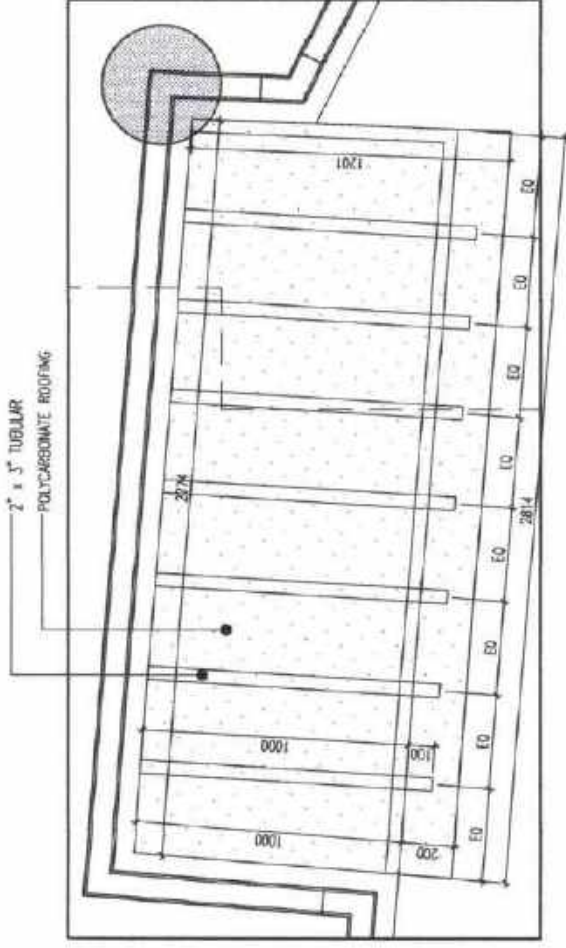

2 PLAN DETAILS  
SCALE: 1/20M

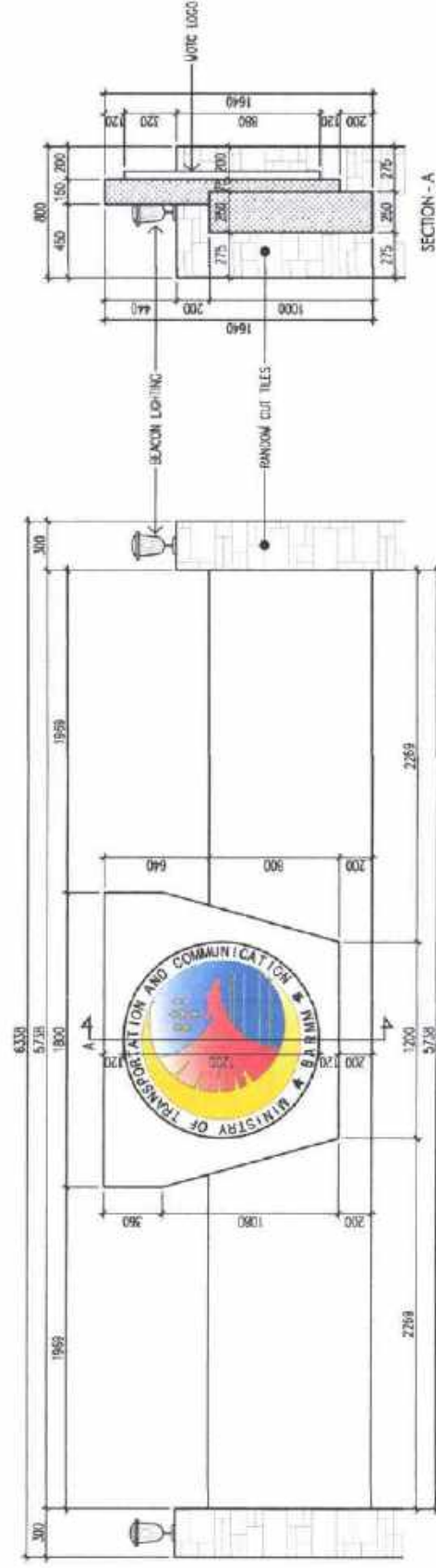

3 SPOT DETAILS  
SCALE: 1/15M



Republic of the Philippines  
MINISTRY OF TRANSPORTATION & COMMUNICATION  
**OFFICE OF THE MINISTER**  
BANGSAW  
CORONA CITY

PROJECT & DESIGN  
CONSTRUCTION OF  
RIVER LANDING  
AT LIBUNGAN, TORRETA, PIGCAWAYAN,  
SGA

REVISIONS  
Checklist of Specifications and other Contract Documents shall be used in accordance with the provisions of the Technical Specifications and Documents of the Project, unless otherwise indicated. The Engineer shall be responsible for any amendments or changes to the Specifications and Documents for any clarification or correction of errors or omissions, with the approval of the Engineer-in-Charge.

DESIGNED BY:  
ENGR. JEFFREY D. ALAGGAR

CHECKED AND REVIEWED BY:  
ENGR. MARICORAL M. MORALES

DATE: 02  
AR-08

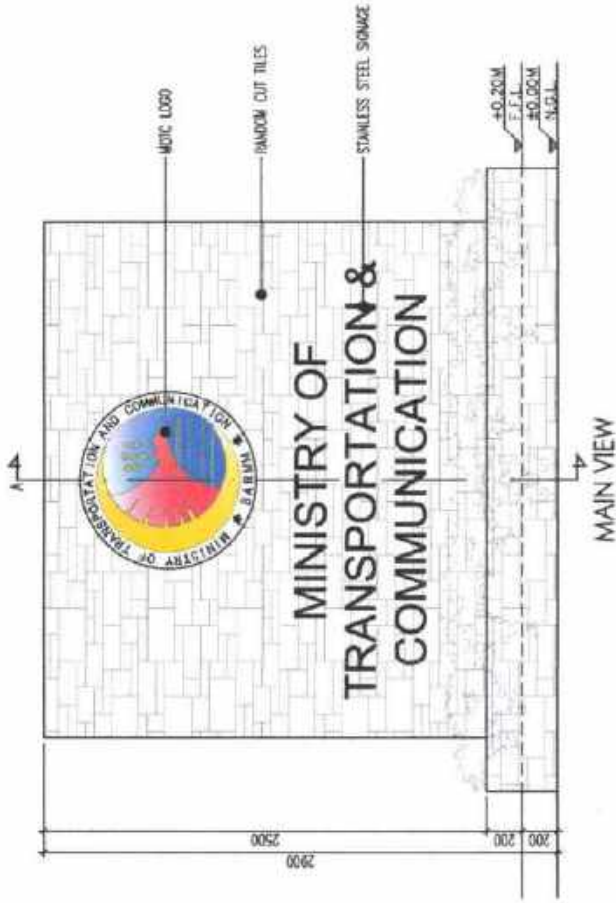

MAIN VIEW

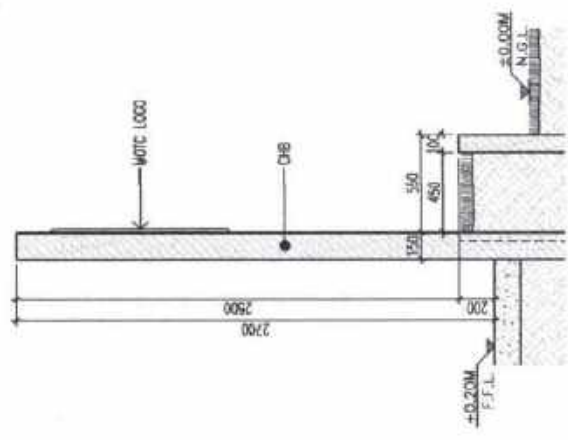

SECTION A

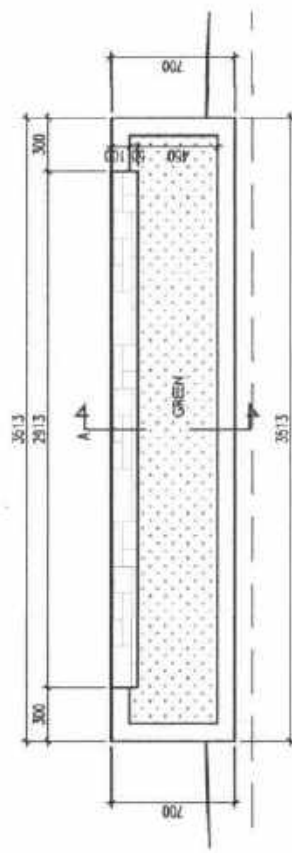

PLAN

1 SIGNAGE DETAILS  
SCALE: 1:300



Republic of the Philippines  
MINISTRY OF TRANSPORTATION & COMMUNICATION  
**OFFICE OF THE MINISTER**  
BUREAU  
COTABATO CITY

PROJECT A LOCATION:  
CONSTRUCTION OF  
RIVER LANDING  
AT LIBUNGAN, TORRETA, PIGCAWAYAN,  
SGA

SHEET CODE: DETAILS

FOR YOUR REFERENCE AND INFORMATION TO:  
Change and Specifications shall be subject to the approval of the Engineer-in-Charge and the Architect. The Engineer-in-Charge and the Architect shall be jointly and severally liable for any errors or omissions in the documents. Documents shall be prepared and submitted to the Engineer-in-Charge and the Architect for their respective approvals. Documents shall be prepared and submitted to the Engineer-in-Charge and the Architect for their respective approvals.

PREPARED BY:  
JALIL M. MALOMALO  
ARCHITECT

CHECKED AND REVIEWED BY:  
ENGR. ASHRAF D. ALINGGAR  
ENGINEER

SUBMITTED BY:  
ENGR. MAURICIO B. BERNAL  
ENGINEER

SHEET NO.  
AR-08  
03

# STRUCTURAL

1. GENERAL NOTES, CONCRETE, REINFORCING
2. BENT / HOOK, SPLICE, NOTES, DOWEL EMBEDMENT LENGTH  
, AND REINFORCED CONCRETE/BLOCK MASONRY
3. STRUCTURAL SCHEDULE
4. STRUCTURAL DETAILS
5. COLUMN LAYOUT PLAN, COLUMN SCHEDULE
6. FOUNDATION LAYOUT PLAN
7. TIE BEAM LAYOUT PLAN
8. BOND BEAM LAYOUT PLAN
9. BEAM AND SLAB LAYOUT PLAN
10. ROOF BEAM LAYOUT PLAN
11. FIRST LEVEL ROOF PLAN
12. 2ND LEVEL ROOF PLAN
13. ROOF TRUSS SECTION
14. SECTION AND ISOMETRIC

I - GENERAL :

- ALL GUIDELINE SPECIFICATIONS, A3 AND ASTM STANDARDS SHOULD BE THE LATEST AS OF THE DATE OF ISSUE OF DRAWINGS FOR CONSTRUCTION.
- ALL DIMENSIONS SHOWN ARE IN MILLIMETERS AND ELEVATIONS ARE IN METERS UNLESS NOTED OTHERWISE.
- ALL DIMENSIONS, ELEVATIONS AND CONDITIONS AFFECTING THE WORKS AT THE JOB SITE SHALL BE VERIFIED PRIOR TO CONSTRUCTION.
- DO NOT SCALE DRAWINGS.
- FOR LOCATION AND DIMENSIONS OF PARTITIONS, DEPRESSIONS, GROOVES, SLEEVES, CURBS, OPENINGS, EMBEDDED OR ATTACHED ITEMS, REFER TO ARCHITECTURAL, MECHANICAL, ELECTRICAL AND PIPING DRAWINGS.
- DETAILS OF CONSTRUCTION NOT SPECIFICALLY SHOWN SHALL BE CONSTRUCTED IN ACCORDANCE WITH DETAILS SHOWN FOR SIMILAR CONDITIONS AND MATERIALS, AND SHALL BE APPROVED BY THE MOTC ENGINEERING DIVISION REPRESENTATIVE ON SITE.
- ALL ELEVATIONS AND DIMENSIONS OF CONCRETE SLAB AT GRADE LEVEL (GROUND FLOOR) AS ELEVATIONS UNLESS NOTED OTHERWISE ON DRAWINGS, FOR EXACT ELEVATION WITH REFERENCE TO GRADE ELEVATION REFER TO RELEVANT CIVIL DRAWING FOR THE BUILDING.
- ALL UNDERGROUND PIPING AND ELECTRICAL CONDUITS SHALL BE Laid IN PLACE PRIOR TO PLACING OF CONCRETE FOUNDATION OR PAVING/FLOOR SLABS ON GRADE.
- SHOP AND WORKING DRAWINGS COMPLETE WITH DATA SHEETS SHALL BE SUBMITTED TO MOTC ENGINEERING DIVISION REPRESENTATIVE FOR APPROVAL. PLANS, SECTION DETAILS SHOWING EXACT CONSTRUCTION AND EXPANSION JOINTS SHALL BE PREPARED PRIOR TO CONSTRUCTION.
- GROUND WATER WAS ENCOUNTERED IN THE BOREHOLES AT A DEPTH RANGING 3.7M TO 6.0M (EL.7M TO EL. 2.7M) BELOW EXISTING GRADE. THE GROUND WATER IS WELL BELOW THE PROPOSED FOUNDATION LEVEL.
- THE CONTRACTOR SHALL CARRY OUT SOIL INVESTIGATION TO CONFIRM THE PERMISSIBLE BEARING CAPACITY OF 140 KN/M<sup>2</sup> BY CARRYING OUT 3 BOREHOLES UNDER THE BUILDING TO A MINIMUM DEPTH OF 10m EACH.
- WHEREVER FOUNDATIONS AND SLAB ON GRADE ARE SHOWN RESTING ON WELL COMPACTED SELECT FILL, THE CONTRACTOR SHALL ENSURE THAT THE SELECT FILL IS WELL COMPACTED TO MEET THE REQUIREMENTS OF GUIDELINE SPECIFICATION SECTION 02.11.5. EXCAVATION AND BACK FILL.
- CONCRETE FOUNDATIONS (ISOLATED, OR STRIP) SHALL BE TOTALLY ENVELOPED (WATER TANKED) WITH WATERPROOFING MEMBRANE TO PROTECT FROM CORROSION IN ACCORDANCE WITH RC GUIDELINE SPECIFICATIONS SECTION 07.13.0.
- ALL EQUIPMENT PAD SIZES AND CONSTRUCTION DETAILS SHOWN ON DRAWINGS ARE BASED ON APPROVED VENDOR DATA, HOWEVER THESE DATA SHALL BE VERIFIED PRIOR TO CONSTRUCTION, IF EXISTING ACTUAL CONDITION DICTATES CHANGES IN EQUIPMENT DATA.
- DESIGN LOADS
  - DEAD LOADS
    - MARBLE/QUARRY TILES ON 25mm THK MORTAR - 1.10 KN/M<sup>2</sup>
    - 30mm THK SAND SOREED - 1.00 KN/M<sup>2</sup>
    - PROVISION FOR CEILING - 0.15 KN/M<sup>2</sup>
    - MECHANICAL DUCTS ALLOWANCE - 0.20 KN/M<sup>2</sup>
    - LIGHTING FIXTURE & MISC ALLOWANCE - 0.10 KN/M<sup>2</sup>
    - 50mm THK GYPSUM - 1 KN/M<sup>2</sup>
    - SINGLE PLY EPDM MEMBRANE - 0.03 KN/M<sup>2</sup>
    - 100mm THK RIGID INSULATION - 0.22 KN/M<sup>2</sup>
  - ROOF DECK WITHOUT ACCESS AND WITHOUT EQUIPMENT - 1.0 KN/M<sup>2</sup>
  - PAVEMENT AIR CONDITIONING UNIT (ACU) - 2.0 KN/M<sup>2</sup>
- WIND LOAD
 

THE DESIGN BASIC WIND PRESSURE IS BASED ON A WIND VELOCITY OF 96M/P (150KPH) AS PER THE DESIGN CRITERIA, AND ACCORDING TO ASCE 7-02 USING SIMPLIFIED PROCEDURE.
- SEISMIC LOADS
 

IBC 2003 SEISMIC REQUIREMENTS IS USED FOR THE EARTHQUAKE LOADS.

II - CONCRETE :

- DESIGN OF ALL REINFORCED CONCRETE STRUCTURE SHALL BE IN ACCORDANCE WITH THE ACI "BUILDING CODE" (ACI 318-02) STRENGTH METHOD.
- CLASSES OF CONCRETE ARE AS FOLLOWS :

| CLASS                              | MINIMUM TENSILE COMPRESSION STRENGTH       |  |
|------------------------------------|--|--|
|                                    | MINIMUM TENSILE COMPRESSIVE STRENGTH (MPa) | MINIMUM TENSILE COMPRESSIVE STRENGTH (%) |
| (LEAN CONCRETE)                    | 20   | 20                                       |
| (REINFORCED CONCRETE)              | 30   | 30                                       |
| (PRE-STRESSED REINFORCED CONCRETE) | 37.5                                       | 35                                       |

- ALL STRUCTURAL CONCRETE SHALL BE MADE WITH CEMENT AS PER MIN. GUIDELINES SPECIFICATION, BELOW GROUND CONCRETE AND LEAN CONCRETE SHALL BE MADE WITH TYPE-I SULFATE RESISTANT PORTLAND CEMENT. ALL CONCRETE FOR ABOVE GROUND STRUCTURES AND GRADE SLABS SHALL BE MADE WITH TYPE-I (ORDINARY) PORTLAND CEMENT.
- ALL FOOTING EXCAVATIONS SHALL BE INSPECTED AND APPROVED BY THE MOTC ENGINEERING DIVISION REPRESENTATIVE PRIOR TO PLACING OF CONCRETE. EXCAVATION AND BACK FILLING SHALL BE DONE AS PER MIN. GUIDELINE SPECIFICATION.
- EMBEDDED MATERIALS :
  - BEFORE PLACING CONCRETE, CARE SHALL BE TAKEN THAT ALL EMBEDDED ITEMS AND EQUIPMENT ANCHORS ARE IN POSITION AND SECURELY FASTENED IN PLACE.
  - NOT ALL EMBEDDED ITEMS ARE SHOWN IN THE CONCRETE OUTLINE DRAWINGS. REFER TO APPLICABLE ARCHITECTURAL, MECHANICAL, ELECTRICAL AND VENDOR EQUIPMENT DRAWINGS FOR ADDITIONAL DETAILS ON LOCATION, SETTING AND ARRANGEMENT OF EMBEDDED ITEMS LISTED AS FOLLOWS, BUT NOT LIMITED TO :
    - ANCHOR BOLTS AND ANCHORS.
    - ELECTRICAL CONDUITS, APPARATUS AND GROUNDING CONDUCTIONS.
    - STRUCTURAL STEEL, FOR EQUIPMENT AND MISCELLANEOUS STEEL.
    - PIPING, PIPE SLEEVES, METAL INSERTS, FLOOR DRAINS, TRENCH DETAILS AND WEDGE INSERTS.
  - ELECTRIC CONDUITS, PIPING AND ANY OTHER ITEMS TO BE EMBEDDED IN STRUCTURAL CONCRETE SHALL BE MADE IN ACCORDANCE WITH THE ACI "BUILDING CODE" (ACI 318-02) FOR REINFORCED CONCRETE. CHAPTER 19 SECTION 1902 OF RC-303.
  - ALL REINFORCING STEEL CONCRETE ALL EMBEDDED ITEMS SHALL BE WELL SECURED IN POSITION PRIOR TO PLACING CONCRETE. ALL EMBEDDED MATERIALS SHALL BE SHOWN IN SHOP DRAWINGS.
  - WATER STOPS SHALL BE MADE CONTINUOUS BY CAREFULLY MADE FIELD CONNECTIONS. ALL PROJECTING WATER STOPS SHALL BE SUPPORTED AND PROTECTED FROM DAMAGE AND EXPOSURE DURING CONSTRUCTION.
  - ALL PERMISSIBLE EMBEDDED ITEMS CAST IN FOUNDATION SHALL BE GALVANIZED OR COATED WITH ZINC RICH PAINT.
  - ALL ANCHOR BOLTS SHALL BE ASTM A-307 CLASS "A". ANCHOR BOLTS SHALL NOT BE IN CONTACT WITH REINFORCING STEEL. ALL ANCHOR BOLTS SHALL BE HOT-DIP GALVANIZED. SIZE AND DETAILS SHALL BE IN ACCORDANCE WITH APPLICABLE PROJECT DRAWINGS.
- JOINTS AND RECESSES :
  - THE LOCATION AND ARRANGEMENT OF CONSTRUCTION, CONTROL, CONTRACTION AND EXPANSION JOINTS, NOT SHOWN ON DRAWINGS SHALL BE AS APPROVED BY THE MOTC ENGINEERING DIVISION REPRESENTATIVE. LOCATE AND SHOW ALL JOINTS IN SHOP DRAWINGS AND OBTAIN MOTC ENGINEERING DIVISION APPROVAL PRIOR TO COMMENCEMENT OF WORK. JOINTS FOR SLABS ON GRADE SHALL BE IN ACCORDANCE WITH ACI 324.3R.
  - FOR ADDITIONAL RECESSES AND OTHER SMALL OPENINGS, WHICH MAY NOT BE SHOWN ON THE DRAWINGS, REFER TO THE APPLICABLE VENDOR EQUIPMENT DRAWINGS.
  - CONSTRUCTION JOINTS SHALL BE MADE IN ACCORDANCE WITH THE MOTC ENGINEERING DIVISION REPRESENTATIVE.
  - UNLESS NOTED ON DRAWINGS, PROVIDE 12mm THICK EXPANSION (ISOLATION) JOINTS WITH APPROVED FILLER AND SEALANT AT ALL JUNCTIONS OF GRADE SLAB WITH GRADE BEAMS, EQUIPMENT FOUNDATIONS, DRAIN WALLS, COLUMNS, ROOF & PRE-CAST WALLS ETC.
- LOCATION AND CLASSIFICATION OF FINISHES FOR FORMED AND UNFORMED SURFACES SHALL BE AS SHOWN ON THE ARCHITECTURAL DRAWINGS OR AS DIRECTED BY MOTC REPRESENTATIVE.
- EQUIPMENT INSTALLED ON CONCRETE FOUNDATIONS SHALL BE GIVEN FULL AND EVEN BEARING BY USING NON-SHRINK GROUT AS PER SPECIFICATIONS.
- PROVIDE APPROPRIATE DEPRESSIONS IN SLABS FOR FINISHES, MAINTAIN FULL SLAB THICKNESS BELOW THESE DEPRESSIONS AS INDICATED IN DRAWINGS. SET ARCHITECTURAL INTERIOR MATERIAL SCHEDULES, FLOOR PLANS, AND DETAILS OF REQUIRED DEPRESSIONS.
- WATER USED FOR CURING SHALL COMPLY WITH STANDARD SPECIFICATIONS.
- LEAN CONCRETE 50mm THK SHALL BE PROVIDED BELOW ALL CONCRETE FOUNDATIONS AND GRADE BEAMS. POLYETHYLENE TAPE OR BARRIER 200 MICRON SHALL BE PROVIDED BELOW THE REINFORCED CONCRETE SLAB ON-GRADE AND BELOW FOUNDINGS AND ABOVE LEAN CONCRETE.
- ALL EXPOSED FACES OF CONCRETE FOUNDATIONS, GRADE BEAMS, WALLS AND ALL CONCRETE IN DIRECT CONTACT WITH EARTH SHALL BE COATED WITH TWO COATS OF BITUMINOUS COATINGS OR GALVALUT EPOXY TO A DRY FILM THICKNESS OF 0.2mm EACH. CORROSION PROTECTION SHALL BE IN ACCORDANCE WITH MOTC ENGINEERING DIVISION DESIGN CRITERIA.
- ALL EXPOSED EDGES OF WALLS, COLUMNS, PLASTERS, BEAMS, CURBS, EQUIPMENT PADS SHALL HAVE A CHAMFER OF 20mm.

III - REINFORCING : (REFER TO RC SPECIFICATIONS SECTION 03.05)

- REINFORCING STEEL :
  - ALL REINFORCING STEEL BARS SHALL BE HOT ROLLED MEDIUM TENSILE DEFORMED BILLET STEEL BARS CONFORMING TO S450 BSA 2 OR ASTM A618M OR ASTM, GRADE 60 (#4, #6).
  - STRUCTURAL STEEL BARS OF GRADE SHALL CONFORM TO S450 BSA 224 OR ASTM A1188 CONFORMING TO S450 BSA 2 OR ASTM A618M OR ASTM, GRADE 60 (#4, #6).
  - WELDED WIRE FABRIC SHALL BE TYPE 10 OR 10.5 WITH 12.5mm (1/2") SQUARE CELLS AND SHALL BE EITHER EPOXY COATED OR GALVANIZED AS PER ASTM A-707. WELDED WIRE FABRIC FOR PRECAST ELEMENTS AND TOPPING OF PRE-STRESSED PRECAST SLABS SHALL BE GRADE 60, 414M#6.
- DETAILING :
  - REINFORCEMENT SHALL BE IN ACCORDANCE WITH APPLICABLE REQUIREMENTS OF THE ACI BUILDING CODE (ACI-318-05), FOR REINFORCED CONCRETE, CHAPTER 7 AND ACI 318-02, CHAPTER 7, FOR PRECAST CONCRETE. FOR DETAILING REINFORCED CONCRETE STRUCTURES, AND RC GUIDELINE SPECIFICATION SECTION 03.05.
  - DIMENSIONS AND SPACING OF BARS ARE TO THE CENTERLINE OF THE BARS UNLESS OTHERWISE NOTED.
  - PLACING OF REINFORCING BARS :
    - ALL REINFORCING BARS SHALL BE PLACED IN ACCORDANCE WITH THE REQUIREMENTS OF CHAPTER 7 OF ACI BUILDING CODE (ACI-318-05).
    - REINFORCEMENT MAY BE MOVED WITH APPROVAL OF THE MOTC ENGINEERING DIVISION REPRESENTATIVE AS NECESSARY TO CLEAR THE PIPES, SEAL RECESSES, EMBEDDED ITEMS, AND CONDUITS, EXCEPT IN AREAS WHERE REINFORCEMENT IS CONCENTRATED IN THE LATER CASE. RELOCATION OF EMBEDDED MATERIALS MUST BE CONSIDERED. IN NO CASE, BARS SHALL BE BENT AGAINST THE REINFORCEMENT. REINFORCEMENT SHALL BE PLACED IN ACCORDANCE WITH THE MOTC ENGINEERING DIVISION REPRESENTATIVE'S APPROVAL.
    - THE USE OF BAR ENLARGERS SHALL CONFORM TO STANDARD SPECIFICATIONS FOR BAR SUBSTITUTIONS CONTAINED IN THE ACI 318-08. EXCEPT AS NOTED ON DRAWINGS, THE USE OF PRECAST CONCRETE OR MORTAR BLOCKS AS BAR SUPPORT AND SPACERS, SHALL BE PROHIBITED.
    - MINIMUM CONCRETE COVER FOR REINFORCING BARS IN CAST-IN-PLACE CONCRETE SHALL BE IN ACCORDANCE WITH STANDARD GUIDELINE SPECIFICATION AND PROVIDED AS FOLLOWS, UNLESS OTHERWISE NOTED :
      - FOOTINGS OR BEAMS CAST AGAINST AND PERMANENTLY EXPOSED TO EARTH/CONCRETE EXPOSED TO SPRAWK POTABLE AND TREATED WATER, INTERIOR OF UNDERGROUND MANHOLE - 75MM - 75MM
      - FORMED SURFACES EXPOSED TO WEATHER OR EARTH - 25MM
      - FOAMED SURFACES NOT EXPOSED DIRECTLY TO WEATHER OR EARTH :
        - SLABS, WALLS, JOISTS - 25MM
        - BEAMS, COLUMNS, COLUMNS - 40MM
        - CONCRETE SLAB OVER 200mm SUB-SLAB, SOE WALK - 50MM
      - PRECAST CONCRETE :
        - EXPOSED TO WEATHER OR EARTH :
          - WALLS, JOISTS - 30MM
          - OTHER MEMBERS ALL SIZES - 30MM
        - NOT EXPOSED TO WEATHER :
          - SLABS, WALLS AND JOISTS ALL SIZES - 20MM
          - BEAMS AND COLUMNS :
            - STRIPS OR TIES - 20MM
            - PRIMARY REINFORCEMENT - 30MM
    - REINFORCING BARS SHALL NOT BE BENT OR STRAIGHTENED IN A MANNER THAT WILL INJURE THE MATERIAL BARS WITH KINKS OR IMPROPER BENDS SHALL NOT BE USED UNLESS PARTIALLY EMBEDDED IN CONCRETE SHALL BE FIELD BENT. EXCEPT AS SHOWN ON THE DRAWINGS, REINFORCEMENT MAY BE BENT IN THE FIELD TO CLEAR WATER STOPS AND KEYS. BARS AT EDGES OF SMALL DOMINIONS (MAXIMUM 600mm) IN FLOORS AND WALLS MAY BE CUT TO SUIT IN THE FIELD, OR SPREAD APART NOT MORE THAN 1.5 TIMES THE BAR SPACING. PROVIDE TRIM BARS TO REPLACE AND LAP THOSE CUT. ALL CUT ENDS AND DAMAGED EPOXY COATING SHALL BE REPAIRED USING FIELD TOUCH UP REPAIR KIT SUPPLIED BY APPROVED MANUFACTURER.
    - THE FIRST AND LAST BAR SPACE SHALL BE ONE-HALF BAR SPACE AS SHOWN UNLESS OTHERWISE NOTED.
    - THE CLEAR DISTANCE BETWEEN SPACED BARS IN A LAYER SHALL NOT BE LESS THAN THE CLEAR DISTANCE BETWEEN BARS IN AN ADJACENT LAYER. THE CLEAR DISTANCE BETWEEN LONGITUDINAL BARS IN COLUMNS SHALL NOT BE LESS THAN 1.5 TIMES THE NOMINAL BAR DIAMETER NOR 40mm.
    - THE CLEAR DISTANCE LIMITATION BETWEEN BARS SHALL ALSO APPLY TO THE CLEAR DISTANCE BETWEEN A CONTACT LAP SPACE AND ADJACENT SPACES OF BARS.

REPUBLIC OF THE PHILIPPINES  
MINISTRY OF TRANSPORTATION AND COMMUNICATION  
**OFFICE OF THE MINISTER**  
CITY OF MANILA

PROJECT & LOCATION  
CONSTRUCTION OF REVER LANG AT  
UBUONGAL, TERRETA, PANGASANYAN, SGA

3/ELECTRICAL  
S-1  
14

---

DESIGNER  
  
ENGR. R. S. ARANGO

ENGINEER  
  
ENGR. R. S. ARANGO

ENGINEER  
  
ENGR. R. S. ARANGO

---

REVISIONS

APPROVED AND FORWARDED BY  
  
ENGR. R. S. ARANGO

SUBMITTED BY  
  
ENGR. R. S. ARANGO

IV - BENT / HOOK : NOTE: DETAILS SHOWN BELOW ARE FOR EPOXY COATED BARS. 0



MINIMUM BEND DIAMETER (D) FOR EPOXY COATED REBARS (MAIN BARS, TIES AND STRIPPINGS) AS PER ASTM A775.

| BAR BEND SIZE (mm) | BAR BEND DIAMETER (mm) |
|--------------------|------------------------|
| 10                 | 84                     |
| 12                 | 104                    |
| 14                 | 124                    |
| 16                 | 144                    |
| 18                 | 164                    |
| 20                 | 184                    |
| 22                 | 204                    |
| 24                 | 224                    |
| 26                 | 244                    |
| 28                 | 264                    |
| 30                 | 284                    |

FOR NON-EPOXY COATED BARS, MULTIPLIER OF 1.2 SHALL BE REPLACED BY 1.0 AND FOR MINIMUM BEND DIAMETER, REFER TO ACI 318.

V - SPLICE :

1. LOCATION OF SOME SPLICES ARE SHOWN ON DRAWINGS. SPLICES NOT SHOWN SHALL BE IN ACCORDANCE WITH THE REQUIREMENTS OF CONCRETE REINFORCING STEEL INSTITUTE (CRSI) - MANUAL OF STANDARD PRACTICE AND AS APPROVED BY RC REPRESENTATIVE.
2. ALL SPLICING OF REINFORCING BARS SHALL BE DONE BY LAPPING UNLESS OTHERWISE APPROVED. BARS SPLICED BY NON-CONTACT LAP SPLICES IN FLEXURAL MEMBERS SHALL NOT BE SPACED TRANSDIRENTELY FARTHER APART THAN ONE-FIFTH THE REQUIRED LAP LENGTH FOR 100mm.
3. ALL TENSION LAP SPLICES SHALL BE CLASS B AS DEFINED IN ACI 318-05 SEC. 12.15.2. TENSION LAP SPLICE LENGTH SHALL BE 7.25L WHERE L IS THE TENSILE DEVELOPMENT LENGTH IN ACCORDANCE WITH ACI 318-05 SECTION 12.2 WITHOUT THE MODIFICATION FACTOR OF 1.25 OR MINIMUM OF 40 BAR DIAMETER WHICH-EVER IS GREATER.
4. COMPRESSION LAP SPLICE LENGTH (IN INCHES) SHALL BE 300 MIN. WHERE D IS THE DIAMETER OF BAR IN INCHES.
5. ALL SLAB REINFORCEMENT SPLICES SHALL BE MADE SUCH THAT THE REQUIRED DISTANCES TO THE FACE OF WALL, SLABS OR REFERENCE LINES ARE MAINTAINED.
6. SPLICES FOR ADJACENT REBARS SHALL BE STAGGERED.

NOTES :

1. FOR BARS SPACED LATERALLY AT LEAST 150mm ON CENTER AND AT LEAST 75mm FROM THE SIDE FACE OF MEMBER, USE 0.8 LD BUT THE LAP SPLICE LENGTH SHALL NOT BE LESS THAN 300mm.
2. TOP BARS ARE HORIZONTAL AND INCLINED REINFORCING BARS SO PLACED THAT MORE THAN 0.30 M. OF CONCRETE IS CAST IN THE MEMBER BELOW THE BARS.
3. ALL SPLICES NOT INCLUDED ON PLAN SHALL BE TENSION SPLICES.

| BAR DIAMETER | SPLICES OF REINFORCED BARS IN TENSION |                  | SPLICES OF REINFORCED BARS IN COMPRESSION |                  |
|--------------|---------------------------------------|------------------|---|------------------|
|              | TOP BARS (mm)                         | BOTTOM BARS (mm) | TOP BARS (mm)                             | BOTTOM BARS (mm) |
| 10-12-14-16  | 350                                   | 400              | 300                                       | 350              |
| 18           | 400                                   | 450              | 350                                       | 400              |
| 20           | 450                                   | 500              | 400                                       | 450              |
| 22           | 500                                   | 550              | 450                                       | 500              |
| 24           | 550                                   | 600              | 500                                       | 550              |
| 26           | 600                                   | 650              | 550                                       | 600              |
| 28           | 650                                   | 700              | 600                                       | 650              |
| 30           | 700                                   | 750              | 650                                       | 700              |

VI - DWEL EMBEDMENT LENGTH : (STANDARD HOOKS IN TENSION) LDH

1. THE MINIMUM DWEL EMBEDMENT LENGTH (mm) SHALL BE AS FOLLOWS.

| EMBEDD CLASS | BAR SIZE |     |     |     |     |
|--------------|----------|-----|-----|-----|-----|
|              | 10       | 12  | 16  | 20  | 25  |
| 6000 PSI     | 190      | 240 | 290 | 340 | 480 |
| 5000 PSI     | 170      | 215 | 266 | 316 | 450 |

2. ALL BARS MARKED CONTINUOUS SHALL BE PROPERLY LAPPED AT SPLICES AND CORNERS AND HOOKED AT NON-CONTINUOUS ENDS.

3. WELDING OF REINFORCING BARS WHERE PERMITTED SHALL BE PERFORMED IN ACCORDANCE WITH AWS D 1.4 STRUCTURAL WELDING CODE.

VII - REINFORCED CONCRETE - BLOCK MASONRY :

1. CONCRETE MASONRY UNITS SHALL BE GRADE "N-1" UNITS CONFORMING TO ASTM C90, ASTM C128, SPECIFICATIONS D4220 AND SHALL HAVE A COMPRESSIVE STRENGTH OF "Fm" BASED ON NET AREA AS FOLLOWS:  
a) FOR LOAD BEARING CMU  $F_m=1200 \text{ psi}$   
b) FOR NON LOAD BEARING CMU  $F_m=500 \text{ psi}$ .
2. REINFORCING BARS SHALL CONFORM TO S542 GRADE 60 SHALL BE USED FOR ALL WALLS.
3. PORTLAND CEMENT SHALL BE ASTM C150 TYPE-I, NON-STAINING OF NATURAL COLOR OR WHITE.
4. MORTAR SHALL BE TYPE S AND SHALL HAVE A MINIMUM COMPRESSIVE STRENGTH OF 1,800 PSI (12.4 MPa) AT 28 DAYS, IN ACCORDANCE WITH RC SPECIFICATIONS CHD9.
5. GROUT SHALL HAVE A FLUID CONSISTENCY FOR POURING WITHOUT SEGREGATION. AGGREGATE SHALL CONFORM TO ASTM C 404. THE COMPRESSIVE STRENGTH AT 28 DAYS SHALL BE 2,000 PSI (14MPa), IN ACCORDANCE WITH RC SPECIFICATIONS CHD9G.
6. ALL NON-LOAD BEARING WALLS SHALL BE SKINNED ONLY AT LOCATION OF VERTICAL REINFORCEMENTS.

VIII - PRECAST CONSTRUCTION : (REFER TO RC SPECIFICATION 03430.034450)

1. DESIGN AND CONSTRUCTION OF PRECAST ELEMENTS SHALL BE IN ACCORDANCE WITH ROYAL COMMISSION PROJECT SPECIFICATIONS SECTIONS 03430 AND 03440 AND THE PRECAST/PRESTRESSED DESIGN CRITERIA STRUCTURAL AND PRECAST INSTITUTE MANUALS.
2. TENSILE STRENGTH OF PRESTRESSING STRAND SHALL BE 270ksi (1863 MPa) AND SHALL BE OF LOW RELAXATION TYPE CONFORMING TO ASTM A420 GRADE 270. IT SHALL BE IN ACCORDANCE WITH ROYAL COMMISSION PROJECT SPECIFICATIONS 03380.
3. UNCOATED STRESS-RELIEVED STEEL WIRE SHALL CONFORM TO ASTM A421M.
4. HIGH TENSILE STRENGTH ALLOW BARS SHALL CONFORM TO ASTM A722M WITH A MINIMUM STRENGTH OF 900ksi.
5. ALL REINFORCEMENT DETAILS FOR HOLLOW CORE SHALL BE PROVIDED BY CONTRACTOR THROUGH PRECAST VENDOR TO BE APPROVED BY ROYAL COMMISSION.



Ministry of Transportation and Communication  
OFFICE OF THE MINISTER  
OTTAWA, ONTARIO

PROJECT & LOCATION  
CONSTRUCTION OF REVER LANS AT  
LUBUNGAN, TORRETA, PISCAPAYAN, SOA

SHEET CORRIDOR  
BENT/HOOK  
-CHISE  
-NOTES  
-DWEL EMBEDMENT LENGTH  
-REINFORCED CONCRETE/BLOCK MASONRY

DESIGN APPROVAL SECTION  
Average and verification of the design documents shall be the responsibility and liability of the contractor who shall be responsible for the accuracy of the drawings. The contractor shall be responsible for the accuracy of the drawings. The contractor shall be responsible for the accuracy of the drawings.

DESIGNER  
ENGINEER

CHECKED AND REWARDED BY  
ENGINEER

SUBMITTED BY  
ENGINEER

SHEET No.  
S-2  
14





COLUMN

| COLUMN MARK | SECTION        |                    | VERTICAL STEEL | STIRRUPS |
|-------------|----------------|--------------------|----------------|----------|
|             | WIDTH "B" (Cm) | THICKNESS "T" (Cm) |                |          |
| C1          | 450            |                    | 8018           | 010018   |
| C2          | 30             | 80                 | 10018          | 3-010018 |
| C3          | 20             | 312                | 20018          | 500 DET. |
| C4          | 20             | 20                 | 0018           | 2-010018 |
| P1          | 200            |                    | 4018           | 010018   |
| P2          | 120            | 120                | 20018          | 010020   |

SLAB SCHEDULE

| SLAB MARK | SECTION THICKNESS "T" (Cm) | BOT. REINF.  |              |              | TOP REINF.   |              |              | REMARKS              |
|-----------|----------------------------|--------------|--------------|--------------|--------------|--------------|--------------|----------------------|
|           |                            | SHORT A      | LONG B       | ADDITIONAL C | SHORT D      | LONG E       | ADDITIONAL F |                      |
| S         | 12                         | 0100150m C/C | 0120150m C/C | -            | 0100150m C/C | 0100150m C/C | 0100000m C/C | TWO WAY SLAB         |
| RAMP      | 12                         | 0100000m C/C | 0100150m C/C | -            | 0100150m C/C | 0100150m C/C | 0100000m C/C | SEE ATTACHED DETAILS |

FOUNDATION SCHEDULE FOR SOIL BEARING CAPACITY OF 140 KPa AT 1M DEPTH  
(SEE NOTE 4)

| FOOTING MARK | LENGTH "A" (Cm) | WIDTH "B" (Cm) | THICKNESS "T" (Cm) | BOT. REINF.    |               |               | TOP REINF.    |                 | REMARKS |
|--------------|-----------------|----------------|--------------------|----------------|---------------|---------------|---------------|-----------------|---------|
|              |                 |                |                    | LONG BAR       | SHORT BAR     | STIRRUPS      | LONG BAR      | SHORT BAR       |         |
| F-1          | 140             | 140            | 40                 | 012 @ 150cm/c  | 012 @ 150cm/c | -             | -             | -               |         |
| F-2          | 175             | 185            | 40                 | 015 @ 200cm/c  | 018 @ 150cm/c | 012 @ 200cm/c | 012 @ 200cm/c | -               |         |
| F-3          | 295             | 245            | 40                 | 018 @ 150cm/c  | 018 @ 150cm/c | 012 @ 200cm/c | 012 @ 200cm/c | AS SHOWN (PLAN) |         |
| F-4          | 180             | 180            | 30                 | 018 @ 150cm/c  | 018 @ 150cm/c | -             | -             | -               |         |
| WALL FOOTING |                 |                |                    |                |               |               |               |                 |         |
| WF           | VARIES          | 200            | 100                | 012 @ 200m c/c | 012 SHORT     | -             | 2-012 LONG    | -               |         |

SCHEDULE OF TRUSS / WEB TRUSS

| ITEM    | KING POST                    | WEB MEM.                     | TOP CHORD                    | BOTTOM CHORD                 |
|---------|------------------------------|------------------------------|------------------------------|------------------------------|
| TRUSS-A | SINGLE ANGLE BAR (2"x2"x5mm) | SINGLE ANGLE BAR (2"x2"x5mm) | SINGLE ANGLE BAR (2"x2"x5mm) | SINGLE ANGLE BAR (2"x2"x5mm) |
| TRUSS-B | SINGLE ANGLE BAR (2"x2"x5mm) | SINGLE ANGLE BAR (2"x2"x5mm) | SINGLE ANGLE BAR (2"x2"x5mm) | SINGLE ANGLE BAR (2"x2"x5mm) |
| TRUSS-C | SINGLE ANGLE BAR (2"x2"x5mm) | SINGLE ANGLE BAR (2"x2"x5mm) | SINGLE ANGLE BAR (2"x2"x5mm) | SINGLE ANGLE BAR (2"x2"x5mm) |

TIE BEAM/BOND BEAM SCHEDULE

| BEAM MARK | SECTION WIDTH "B" (Cm) | THICKNESS "T" (Cm) | BOT. REINF. |              |              | TOP REINF. |              |   | SHIM RFT. STIRRUPS (BOTH FACE) |
|-----------|------------------------|--------------------|-------------|--------------|--------------|------------|--------------|---|--------------------------------|
|           |                        |                    | STRAIGHT A  | ADDITIONAL B | ADDITIONAL C | STRAIGHT D | ADDITIONAL E |   |                                |
| TB        | 55                     | 45                 | 3015        | 0215         | 3015         | 3015       | 010010       | - |                                |
| BB        | 05                     | 20                 | 3015        | -            | 3015         | -          | 010015       | - |                                |

BEAM/ROOF BEAM SCHEDULE

| BEAM MARK | SECTION WIDTH "B" (Cm) | THICKNESS "T" (Cm) | BOT. REINF. |              |              | TOP REINF. |              |   | SHIM RFT. STIRRUPS (BOTH FACE) |
|-----------|------------------------|--------------------|-------------|--------------|--------------|------------|--------------|---|--------------------------------|
|           |                        |                    | STRAIGHT A  | ADDITIONAL B | ADDITIONAL C | STRAIGHT D | ADDITIONAL E |   |                                |
| B1        | 25                     | 50                 | 4015        | 3015         | 4015         | 3015       | 010010       | - |                                |
| B2        | 25                     | 25                 | 2015        | 1015         | 2015         | 3015       | 010010       | - |                                |
| RB1       | 20                     | 40                 | 2015        | -            | 2015         | -          | 010015       | - |                                |
| RB2       | 05                     | 100                | 4015        | -            | 4015         | -          | 010015       | - |                                |



Ministry of Transportation & Communication  
OFFICE OF THE MINISTER  
CAIRO CITY

PROJECT & LOCATION  
CONSTRUCTION OF REBEL LANS AT LIBRIGAN, TORRETA, PISCARRIGAN, SGA

SHEET CONTENTS  
STRUCTURAL SCHEDULE

IN CHARGE ARCHITECT/STRUCTURIST  
I am a duly qualified and registered Architect/Structurist and I hereby certify that the design and construction of the project is in accordance with the relevant codes and standards and I am not aware of any conflict of interest in the design and construction of the project.

DRAWN BY: MOHAMAD ABDEL N. AHMED  
ENGINEER

CHECKED AND APPROVED BY: [Signature]  
ENGINEER

SUBMITTED BY: [Signature]  
ENGINEER

THIS DRAWING IS THE PROPERTY OF MOTC ENGINEERING DIVISION AND IT CANNOT BE REPRODUCED, COPIED OR CIRCULATED WITHOUT THE WRITTEN CONSENT OF THE MOTC ENGINEERING DIVISION

NOTES  
1. ALL DIMENSIONS ARE IN CENTIMETERS UNLESS OTHERWISE NOTED.

- FOR GENERAL NOTES, REFER TO DWG. NO. S-1 & S-2
- CONTRACTOR SHALL PREPARE OR PROVIDE SHOP DRAWINGS AND CALCULATIONS WHEN IT HAVE CHANGES AS PER SITE CONDITION BEFORE PROCEED THE WORK FOR THE APPROVAL OF MOTC ENGINEERING DIVISION.
- CONTRACTOR SHALL VERIFY THE ACTUAL SITE CONDITION OF LOCATION AND EXISTING STRUCTURE BEFORE STARTING THE CONSTRUCTION OF THE PROJECT

- COLUMNS ARE DESIGNED FOR TWO STOREY BUILDING
- SBC ASSUMES 25T/M2
- $f_{cu} = 35 \text{ N/mm}^2$   
 $f_y = 400 \text{ N/mm}^2$
- COLUMN LOADS ARE ULTIMATE IN TON
- MOMENT ARE SERVICE IN TON-m

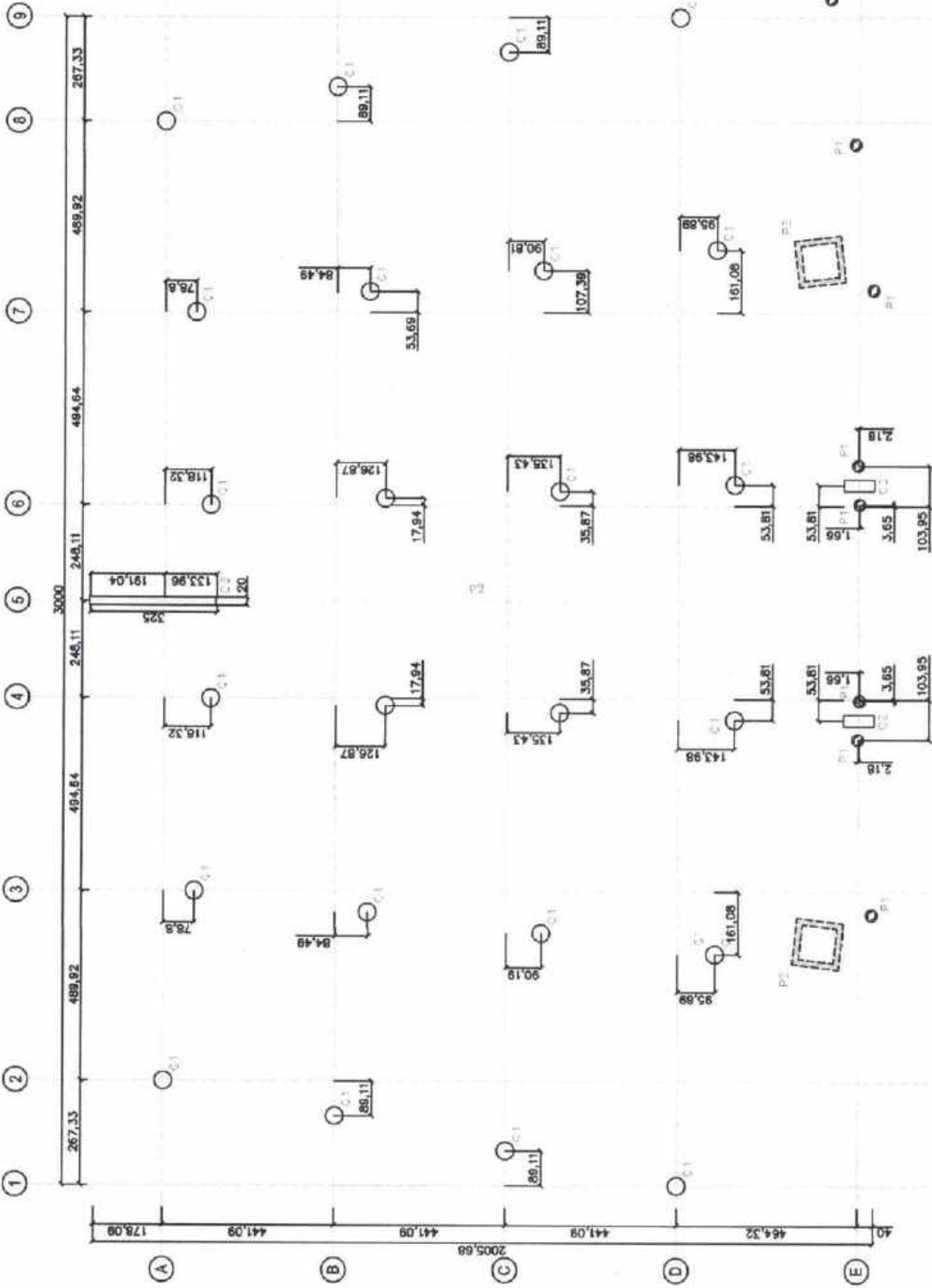

| COLUMN | SECTION | RING | REINFORCEMENT  |
|--------|---------|------|--|
| C1     |         | C    | 10mm @150m C/C   |
| C2     |         | C    | 3-10mm @150m C/C   |
| C3     |         | C    | 3-10mm @150m C/C<br>1 LONG=2<br>2 SHORT=15<br>GROUND FLOOR |
| C4     |         | C    | 2-10mm @150m C/C<br>2ND FLOOR                              |

a COLUMN LAYOUT  
SCALE 1:100 UMS

|   |  |                                     |  |   |                                      |                            |
|---|--|-------------------------------------|--|---|--------------------------------------|----------------------------|
| <br><b>OFFICE OF THE MINISTER</b><br>TRANSPORTATION & COMMUNICATION<br>SARAWAK CITY | PROJECT & LOCATION<br>CONSTRUCTION OF REVEE LAWS AT<br>LIE JURUAN, TORRETA, PUCO AWANG, SGA  | SHEET CONTROL<br>COLUMN LAYOUT PLAN | DRAWN BY<br><br>MOHAMAD RAFIQ A. ALI<br>ENGINEER | CHECKED AND REVIEWED BY<br><br>ENGR. D. ALABDAR | SUBMITTED BY<br><br>ENGR. D. ALABDAR | SHEET NO.<br><br>S-5<br>14 |
|   | IN-SITU APPROVAL/REVISIONS<br>Drawings and specifications and other contract documents may require change or amend. as to standards of work as the project progress and availability of the materials. It is the responsibility of the contractor to ensure that the work is carried out in accordance with the approved drawings and specifications. The contractor shall be responsible for the approval of the drawings and specifications. The contractor shall be responsible for the approval of the drawings and specifications. The contractor shall be responsible for the approval of the drawings and specifications. |                                     |  |   |                                      |                            |

THIS DRAWING IS THE PROPERTY OF MOTC ENGINEERING DIVISION AND IT CANNOT BE REPRODUCED, COPIED OR CIRCULATED WITHOUT THE WRITTEN CONSENT OF THE MOTC ENGINEERING DIVISION

NOTES

1. ALL DIMENSIONS ARE IN CENTIMETERS UNLESS OTHERWISE NOTED.
2. FOR GENERAL NOTES, REFER TO DWG. NO. S-1 & S-2
3. CONTRACTOR SHALL PREPARE OR PROVIDE SHOP DRAWINGS AND CALCULATIONS WHEN IT HAVE CHANGES AS PER SITE CONDITION BEFORE PROCEED THE WORK FOR THE APPROVAL OF MOTC ENGINEERING DIVISION.
4. CONTRACTOR SHALL VERIFY THE ACTUAL SITE CONDITION OF LOCATION AND EXISTING STRUCTURE BEFORE STARTING THE CONSTRUCTION OF THE PROJECT FOR REFERENCE PURPOSE.

EXCAVATE THE CONSTRUCTION AREA UP TO A LEVEL 1.3M, 1.6M, AND 2.2M BELOW THE NATURAL GROUND LEVEL AS PER SECTION DETAILS AND COMPACT THE EXCAVATED SURFACE TO NOT LESS THAN 95% OF THE MAXIMUM DRY DENSITY OF THE SOIL USING A HEAVY VIBRATORY ROLLER. FURTHER, A 200mm THICK ROAD BASE LAYER HAS TO BE PLACED AND COMPACTED TO NOT LESS THAN 98% OF THE MAXIMUM DRY DENSITY OF THE ROAD BASE MATERIAL TO GET THE PROPOSED FOUNDATION LEVEL OF 1.00m - 1.20m BELOW THE ROAD LEVEL. CONTRACTOR SHALL DO SOIL IMPROVEMENT TEST

1. COLUMN ARE DESIGNED FOR TWO STOREY BUILDING
2. SBC ASSUMES 25T/M<sup>2</sup>
3.  $f_{cu} = 35 \text{ N/mm}^2$   
 $f_y = 400 \text{ N/mm}^2$
4. COLUMN LOADS ARE ULTIMATE IN TON
5. MOMENT ARE SERVICE IN TON-M

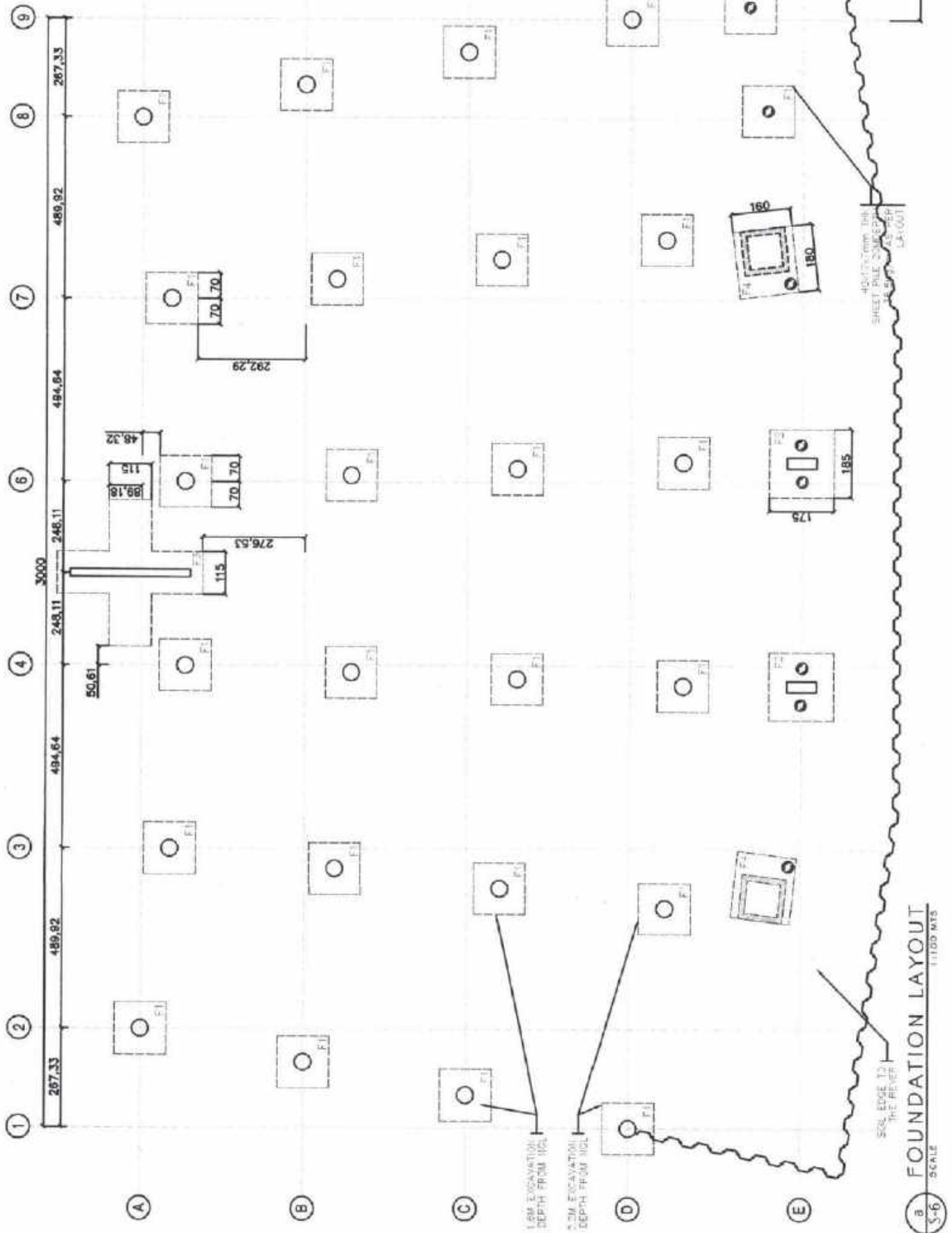

FOUNDATION LAYOUT  
SCALE 1:1100 MTS

|  |   |  |                    |                        |              |   |                          |   |                    |   |              |   |             |
|--|---|--|--------------------|------------------------|--------------|---|--------------------------|---|--------------------|---|--------------|---|-------------|
|  <p>Ministry of Transportation &amp; Communication<br/>OFFICE OF THE MINISTER<br/>KUALA LUMPUR, MALAYSIA<br/>(03) 4741 1211</p> | PROJECT & LOCATION  | CONSTRUCTION OF REVER LANG AT<br>LUBUNGAL TORRETA, RICCANAYAN, SGA | BEST COPY          | FOUNDATION LAYOUT PLAN | DESIGNER     | <br>MICHAEL JOSEPH E. B. B. B.<br>(ENGINEER) | CHECKED AND REVIEWED BY: | <br>ENGR. R. R. R.<br>(ENGINEER) | SUBMITTED BY:      | <br>ENGR. R. R. R.<br>(ENGINEER) | SHEET NO.    | <div style="border: 1px solid black; border-radius: 50%; width: 40px; height: 40px; display: flex; align-items: center; justify-content: center;"> <span style="font-size: 12px;">S-6</span><br/> <span style="font-size: 12px;">14</span> </div> |             |
|  | <p>PLEASE VISIT WEBSITE @ <a href="http://www.motc.gov.my">www.motc.gov.my</a><br/>                 For more information and other contact details<br/>                 the project progress or status in preparing or during<br/>                 the construction phase, please refer to the website<br/>                 available at <a href="http://www.motc.gov.my">www.motc.gov.my</a>.<br/>                 Applies to all cases of the Ministry for use in<br/>                 the execution of all the engineering or design<br/>                 contract of the Ministry or other of all branches.</p> | <p>DRIVEN BY</p>   | <p>DESIGNED BY</p> | <p>DATE</p>            | <p>SCALE</p> | <p>PROJECT NO.</p>  | <p>DATE</p>              | <p>SCALE</p>  | <p>PROJECT NO.</p> | <p>DATE</p>   | <p>SCALE</p> | <p>PROJECT NO.</p>  | <p>DATE</p> |

THIS DRAWING IS THE PROPERTY OF MOTC ENGINEERING DIVISION AND IT CANNOT BE REPRODUCED, COPIED OR CIRCULATED WITHOUT THE WRITTEN CONSENT OF THE MOTC ENGINEERING DIVISION

**NOTES**

- \* ALL TIE BEAMS TOP LEVEL SHALL BE -0.90 FROM REFERENCE LEVEL OR (NATURAL GROUND LEVEL) UNLESS OTHERWISE MENTION IN THE DRAWINGS AND CONFIRM AS PER SITE ACTUAL CONDITION DURING THE IMPLEMENTATION, SEE SECTION FOR REF.
  - \* PROVIDE HOLLOW BLOCK AND BOND BEAM ABOVE TIE BEAM TO RAISE THE FLOOR LEVEL WHEREVER REQUIRED
  - \*  $f_{cu}=40 \text{ N/mm}^2$
  - \*  $f_y=400 \text{ N/mm}^2$
  - \* 10 CM THK GRADE SLAB WITH REINFORCEMENT  $\phi 10 @ 20 \text{ cm}$  MESH BOTHWAYS.
1. ALL DIMENSIONS ARE IN CENTIMETERS UNLESS OTHERWISE NOTED.
  2. FOR GENERAL NOTES, REFER TO DMC. NO. S-1 & S-2
  3. CONTRACTOR SHALL PREPARE OR PROVIDE SHOP DRAWINGS AND CALCULATIONS WHEN IT HAVE CHANGES AS PER SITE CONDITION BEFORE PROCEED THE WORK FOR THE APPROVAL OF MOTC ENGINEERING DIVISION.
  4. CONTRACTOR SHALL VERIFY THE ACTUAL SITE CONDITION OF LOCATION AND EXISTING STRUCTURE BEFORE STARTING THE CONSTRUCTION OF THE PROJECT FOR REFERENCE PURPOSE.

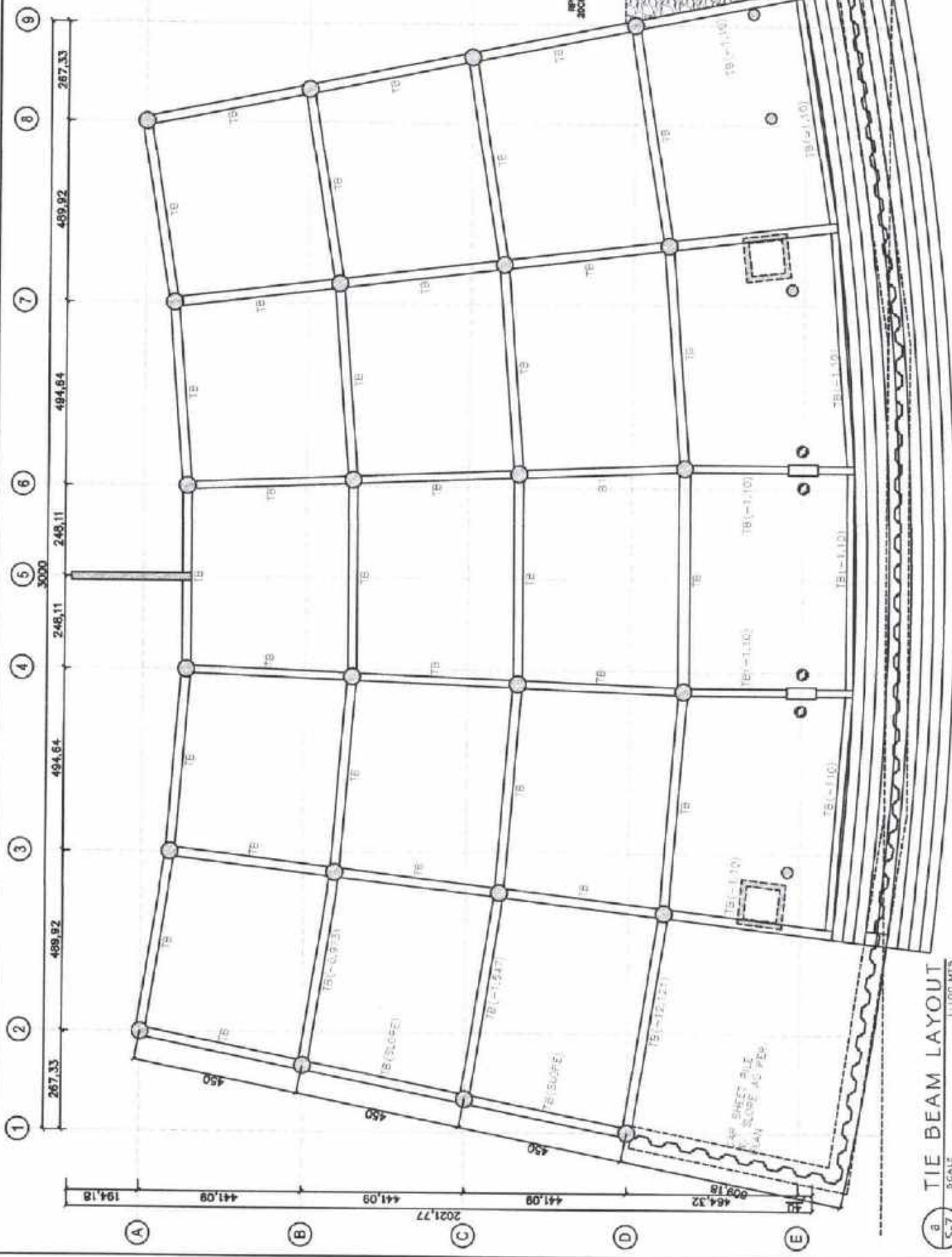

**TIE BEAM LAYOUT**  
SCALE 1:100 METS

|  |   |   |  |  |                                     |                                 |
|--|---|---|--|--|-------------------------------------|---------------------------------|
| <p>Ministry of Transportation &amp; Communications<br/><b>OFFICE OF THE MINISTER</b><br/>SINGAPORE</p> | <p>PROJECT &amp; LOCATION<br/>CONSTRUCTION OF RIVER LANS AT<br/>LEBUJAN, FORBETA, PINGAWAN, SGA</p> | <p>SHEET CONTENT<br/>TIE BEAM LAYOUT PLAN</p> | <p>DESIGNED BY<br/>MICHAEL JOSEPH S. ALVARO<br/>ENGINEER</p> | <p>CHECKED AND REVIEWED BY<br/>[Signature]</p> | <p>SUBMITTED BY<br/>[Signature]</p> | <p>SHEET NO.<br/>S-7<br/>14</p> |
|  | <p>REVISIONS AND COMMENTS<br/>[Blank]</p>   | <p>DRAWN BY<br/>[Signature]</p>               | <p>ENGINEER<br/>MICHAEL JOSEPH S. ALVARO</p>                 | <p>ENGINEER<br/>[Signature]</p>                | <p>ENGINEER<br/>[Signature]</p>     | <p>ENGINEER<br/>[Signature]</p> |

THIS DRAWING IS THE PROPERTY OF MOTC ENGINEERING DIVISION AND IT CANNOT BE REPRODUCED, COPIED OR CIRCULATED WITHOUT THE WRITTEN CONSENT OF THE MOTC ENGINEERING DIVISION

**NOTES**

- ALL BOND BEAMS TOP LEVEL SHALL BE +0.10 FROM REFERENCE LEVEL OR (1M FROM N.G.L.) UNLESS OTHERWISE MENTION IN THE DRAWINGS AND CONFIRM AS PER SITE ACTUAL CONDITION DURING THE IMPLEMENTATION, SEE SECTION FOR REF.
  - PROVIDE WALL FOOTING FOR THE WALL WITHOUT BOND BEAM
  - $f_{cu}=40 \text{ N/mm}^2$
  - $f_y=400 \text{ N/mm}^2$
  - 10 CM THK GRADE SLAB WITH REINFORCEMENT #10@200CM MESH BOTHWAYS.
1. ALL DIMENSIONS ARE IN CENTIMETERS UNLESS OTHERWISE NOTED.
  2. FOR GENERAL NOTES, REFER TO DWG. NO. S-1 & S-2
  3. CONTRACTOR SHALL PREPARE OR PROVIDE SHOP DRAWINGS AND CALCULATIONS WHEN IT HAVE CHANGES AS PER SITE CONDITION BEFORE PROCEED THE WORK FOR THE APPROVAL OF MOTC ENGINEERING DIVISION.
  4. CONTRACTOR SHALL VERIFY THE ACTUAL SITE CONDITION OF LOCATION AND EXISTING STRUCTURE BEFORE STARTING THE CONSTRUCTION OF THE PROJECT FOR REFERENCE PURPOSE

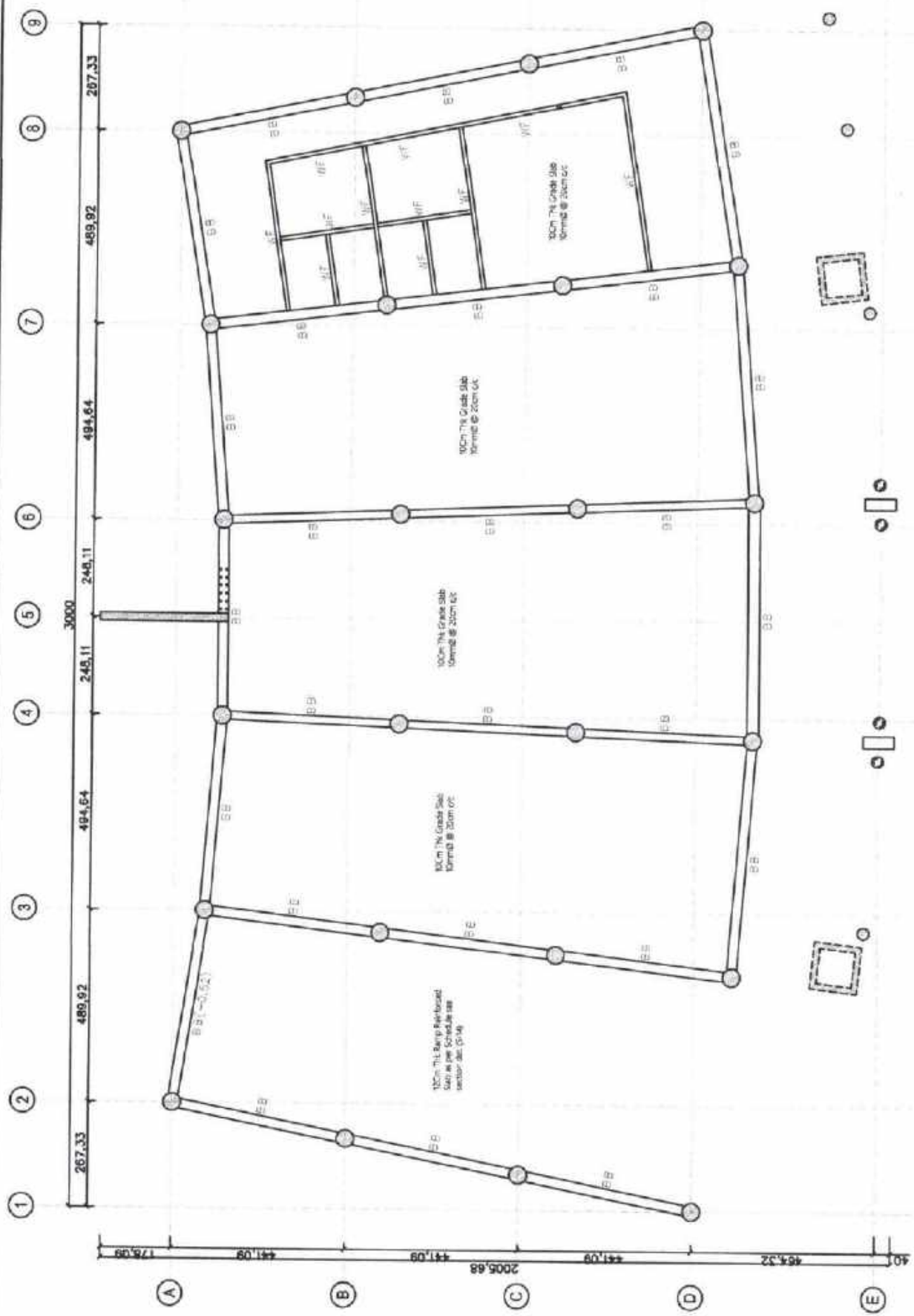

**a BOND BEAM LAYOUT**  
SCALE 1:1000 MTS

|   |   |   |
|---|---|---|
| <p><b>Ministry of Transportation &amp; Communication</b><br/><b>OFFICE OF THE MINISTER</b><br/>DARAVAN<br/>CORRALCAY CITY</p> | <p>PROJECT LOCATION:<br/>CONSTRUCTION OF PE-REP LANS AT<br/>CIBUTIGAN, TORRETA, PISGAWASAN, SSA</p> | <p>SHEET NUMBER:<br/>S-8<br/>14</p>                           |
|   | <p>DESIGNED AND REVIEWED BY:<br/><i>[Signature]</i><br/>ENGR. G. G. G. G.</p>                       | <p>ENGINEER:<br/><i>[Signature]</i><br/>ENGR. G. G. G. G.</p> |
| <p>DATE: 11/11/2024</p>   | <p>PROJECT NO. 1111111111</p>   | <p>SCALE: 1:1000 MTS</p>                                      |
| <p>PROJECT NO. 1111111111</p>   | <p>PROJECT NO. 1111111111</p>   | <p>PROJECT NO. 1111111111</p>                                 |

THIS DRAWING IS THE PROPERTY OF MOTC ENGINEERING DIVISION AND IT CANNOT BE REPRODUCED, COPIED OR CIRCULATED WITHOUT THE WRITTEN CONSENT OF THE MOTC ENGINEERING DIVISION

**NOTES**

- ALL BEAMS TOP LEVEL SHALL BE REFER TO ARCHITECTURAL SECTION FROM REFERENCE UNLESS OTHERWISE MENTION IN THE DRAWINGS AND CONFIRM AS PER SITE ACTUAL CONDITION DURING THE IMPLEMENTATION, SEE SECTION FOR REF.
- PROVIDE DRAFT WALL FROM BEAM AS PER ARCHITECTURAL DRAWINGS

- $f_{cu}=40 \text{ N/mm}^2$
- $f_{yk}=400 \text{ N/mm}^2$
- 12 CM THK SLAB WITH REINFORCEMENT AS PER SCHEDULE

1. ALL DIMENSIONS ARE IN CENTIMETERS UNLESS OTHERWISE NOTED.
2. FOR GENERAL NOTES, REFER TO DWG. NO. S-1 & S-2
3. CONTRACTOR SHALL PREPARE OR PROVIDE SHOP DRAWINGS AND CALCULATIONS WHEN IT HAVE CHANGES AS PER SITE CONDITION BEFORE PROCEED THE WORK FOR THE APPROVAL OF MOTC ENGINEERING DIVISION.
4. CONTRACTOR SHALL VERIFY THE ACTUAL SITE CONDITION OF LOCATION AND EXISTING STRUCTURE BEFORE STARTING THE CONSTRUCTION OF THE PROJECT FOR REFERENCE PURPOSE

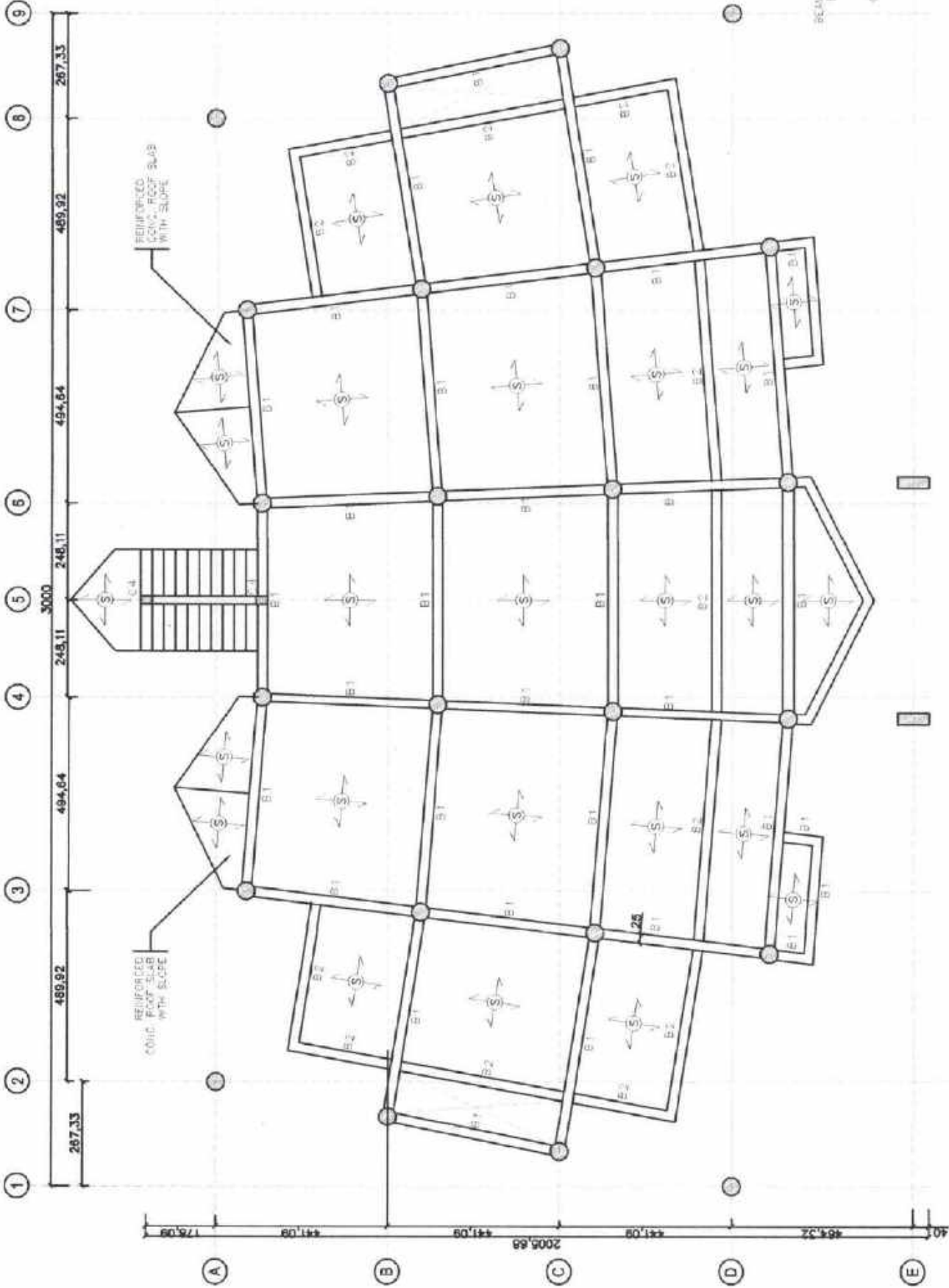

**a** BEAM LAYOUT  
SCALE 1:1100 MTS

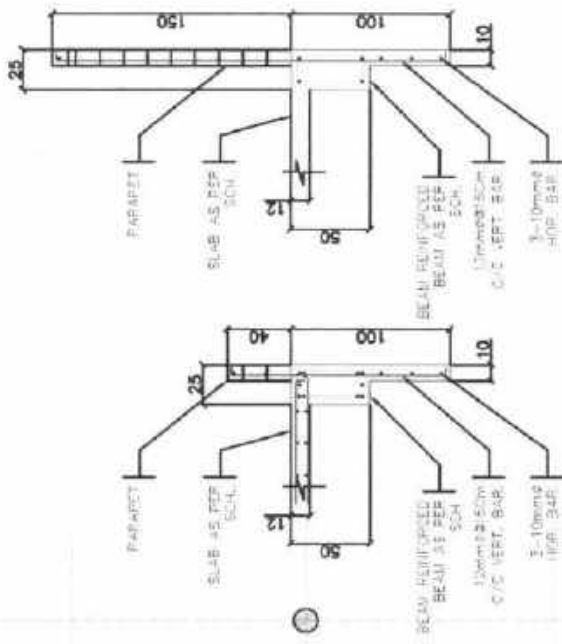

**b** PERIMETER BEAM DET.  
SCALE 1:1100 MTS

|  |  |  |  |   |   |   |   |                                 |
|--|--|--|--|---|---|---|---|---------------------------------|
|  | <p>Ministry of the <i>Transportation &amp; Communication</i><br/>MINISTRY OF TRANSPORTATION &amp; COMMUNICATION<br/><b>OFFICE OF THE MINISTER</b><br/>Islamabad<br/>CO-4810, DIT</p> | <p>PROJECT &amp; LOCATION<br/>CONSTRUCTION OF BEVER LANE AT<br/>LEUVICAN, TORRETA, PISCAGAYAN, SCA</p> | <p>SHEET CONTING<br/>BEAM &amp; SLAB LAYOUT PLAN</p> | <p>SCALE: UNITS IN METERS<br/>Please refer to the drawings and notes. The contractor shall be responsible for the accuracy of the data and the results of the calculations. The contractor shall be responsible for the accuracy of the data and the results of the calculations. The contractor shall be responsible for the accuracy of the data and the results of the calculations.</p> | <p>DRAWN BY:<br/><br/>ENGINEER</p> | <p>CHECKED AND FORWARDED BY:<br/><br/>ENGINEER</p> | <p>SUBMITTED BY:<br/><br/>ENGINEER</p> | <p>SHEET NO.<br/>S-9<br/>14</p> |
|--|--|--|--|---|---|---|---|---------------------------------|

THIS DRAWING IS THE PROPERTY OF MOTC ENGINEERING DIVISION AND IT CANNOT BE REPRODUCED, COPIED OR CIRCULATED WITHOUT THE WRITTEN CONSENT OF THE MOTC ENGINEERING DIVISION

NOTES

• ALL ROOF BEAMS TOP LEVEL SHALL BE REFER TO ARCHITECTURAL SECTION FROM IN THE DRAWINGS AND OTHERWISE MENTION IN ACTUAL CONDITION DURING THE IMPLEMENTATION, SEE SECTION FOR REF.

- $f_{cu}=40 \text{ N/mm}^2$
- $f_y=400 \text{ N/mm}^2$
- 12 CM THK SLAB WITH REINFORCEMENT AS PER SCHEDULE

1. ALL DIMENSIONS ARE IN CENTIMETERS UNLESS OTHERWISE NOTED.
2. FOR GENERAL NOTES, REFER TO DWG. NO. S-1 & S-2
3. CONTRACTOR SHALL PREPARE OR PROVIDE SHOP DRAWINGS AND CALCULATIONS WHEN IT HAVE CHANGES AS PER SITE CONDITION BEFORE PROCEED THE WORK FOR THE APPROVAL OF MOTC ENGINEERING DIVISION.
4. CONTRACTOR SHALL VERIFY THE ACTUAL SITE CONDITION OF LOCATION AND EXISTING STRUCTURE BEFORE STARTING THE CONSTRUCTION OF THE PROJECT FOR REFERENCE PURPOSE

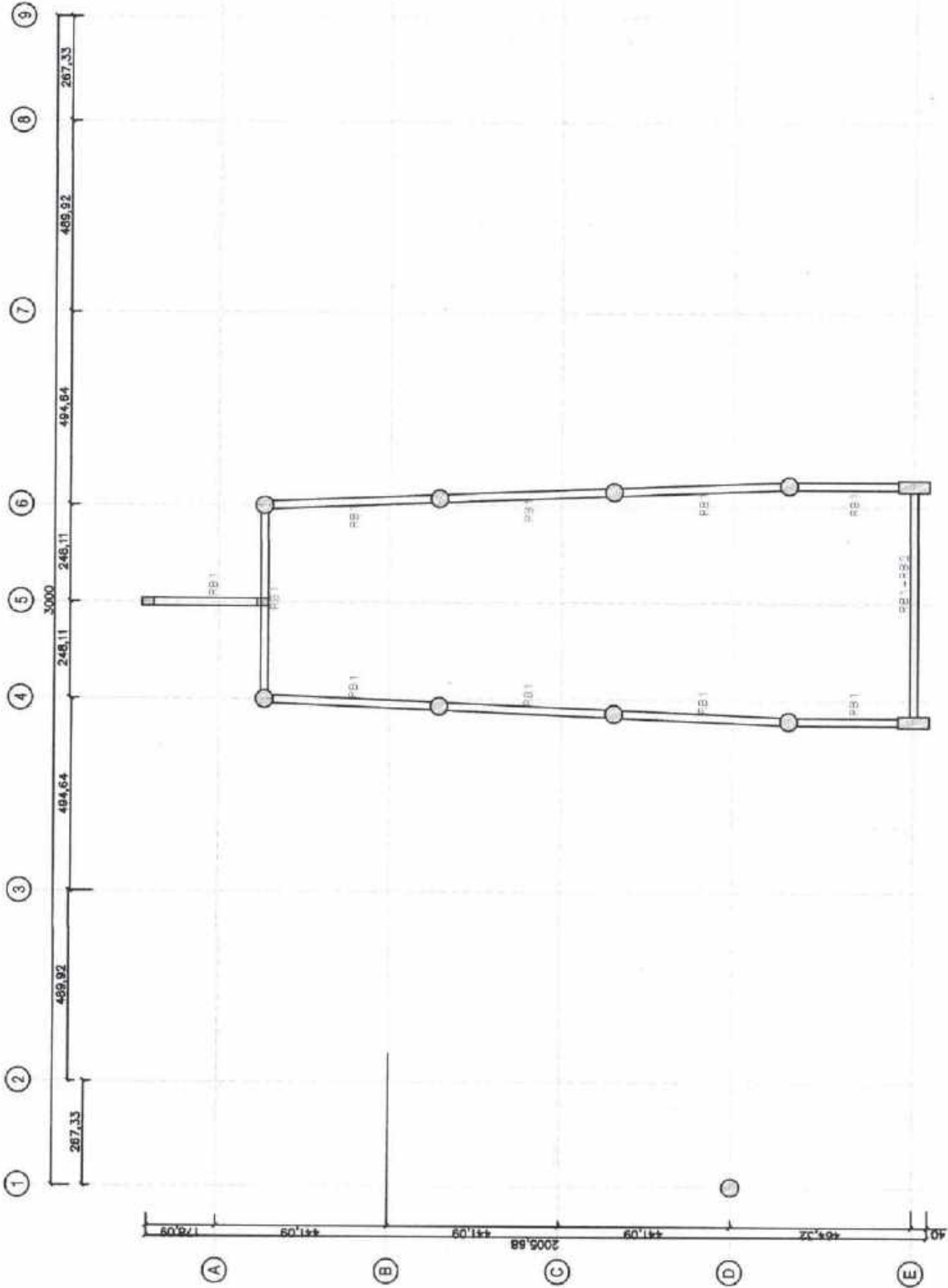

ROOF BEAM LAYOUT  
SCALE 1:1000 MTS

|  |  |  |  |  |   |                                  |
|--|--|--|--|--|---|----------------------------------|
|  | <p>PROJECT &amp; LOCATION<br/>CONSTRUCTION OF REVER LAUD AT LIBURHAN, TORRETA, PIGDAWANAN, SOA</p> | <p>SHEET CONTENT<br/>ROOF-BEAM LAYOUT PLAN</p> | <p>DESIGNER<br/>MOHDIAZ ABRAE F. ALSHAD<br/>ENGINEER</p> | <p>CHECKED AND REVIEWED BY<br/><i>[Signature]</i><br/>ENGINEER</p> | <p>SUBMITTED BY<br/><i>[Signature]</i><br/>ENGINEER</p> | <p>SHEET NO.<br/>S-10<br/>14</p> |
|--|--|--|--|--|---|----------------------------------|



THIS DRAWING IS THE PROPERTY OF MOTC ENGINEERING DIVISION AND IT CANNOT BE REPRODUCED, COPIED OR, CIRCULATED WITHOUT THE WRITTEN CONSENT OF THE MOTC ENGINEERING DIVISION

**NOTES**

• TRUSS MEASUREMENT SHOULD VERIFY AS PER SITE ACTUAL CONDITION BEFORE FABRICATION

- $f_{cu}=40 \text{ N/mm}^2$
- $f_y=400 \text{ N/mm}^2$
- 12 CM THK SLAB WITH REINFORCEMENT AS PER SCHEDULE

1. ALL DIMENSIONS ARE IN CENTIMETERS UNLESS OTHERWISE NOTED.
2. FOR GENERAL NOTES, REFER TO D.W.C. NO. S-1 & S-2
3. CONTRACTOR SHALL PREPARE OR PROVIDE SHOP DRAWINGS AND CALCULATIONS WHEN IT HAVE CHANGES AS PER SITE CONDITION BEFORE PROCEED THE WORK FOR THE APPROVAL OF MOTC ENGINEERING DIVISION.
4. CONTRACTOR SHALL VERIFY THE ACTUAL SITE CONDITION OF LOCATION AND EXISTING STRUCTURE BEFORE STARTING THE CONSTRUCTION OF THE PROJECT FOR REFERENCE PURPOSE

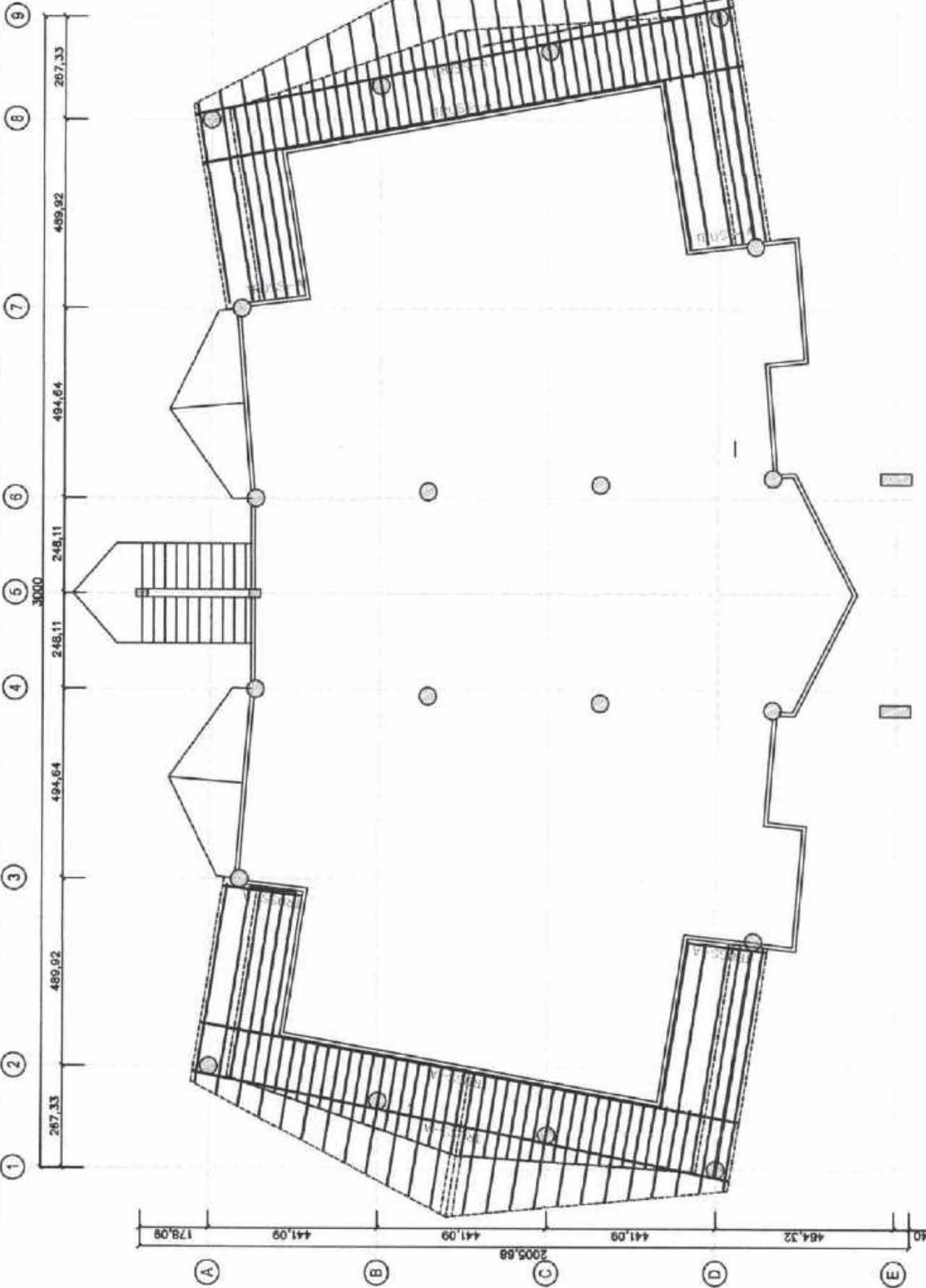

**a** FIRST LEVEL ROOF LAYOUT  
SCALE 1:1000 MTS

|  |   |  |   |  |  |   |   |                                  |
|--|---|--|---|--|--|---|---|----------------------------------|
|  | <p>Ministry of Transportation &amp; Communication<br/><b>OFFICE OF THE MINISTER</b><br/>SINGAPORE</p> | <p>PROJECT &amp; LOCATION<br/>CONSTRUCTION OF PEVEP LANE AT<br/>LILINGGAN, TORRETA, POGONGTAN, SGA</p> | <p>SHEET CODE(S)<br/>FIRST LEVEL ROOF LAYOUT PLAN</p> | <p>DESIGNER'S REMARKS<br/>Drawing and construction are per contract documents. Any change or modification of drawings or notes, shall be done in writing and signed by the architect. It is the contractor's responsibility to verify the accuracy of the drawings and notes before construction. The contractor shall be responsible for any errors or omissions in the drawings and notes, which may affect the construction of the project.</p> | <p>DESIGNER'S SIGNATURE<br/>MCHAMUD, JESSE A. ALIUD<br/>REGISTERED</p> | <p>CHECKED AND REVIEWED BY<br/>[Signature]<br/>REGISTERED</p> | <p>SUBMITTER'S SIGNATURE<br/>[Signature]<br/>REGISTERED</p> | <p>SHEET NO.<br/>S-11<br/>14</p> |
|--|---|--|---|--|--|---|---|----------------------------------|

THIS DRAWING IS THE PROPERTY OF MOTC ENGINEERING DIVISION AND IT CANNOT BE REPRODUCED, COPIED OR CIRCULATED WITHOUT THE WRITTEN CONSENT OF THE MOTC ENGINEERING DIVISION

**NOTES**

- TRUSS MEASUREMENT SHOULD VERIFY AS PER SITE ACTUAL CONDITION BEFORE FABRICATION
  - $f_{cu}=40 \text{ N/mm}^2$
  - $f_y=400 \text{ N/mm}^2$
  - 12 CM THK SLAB WITH REINFORCEMENT AS PER SCHEDULE
1. ALL DIMENSIONS ARE IN CENTIMETERS UNLESS OTHERWISE NOTED.
  2. FOR GENERAL NOTES, REFER TO DWG. NO. S-1 & S-2
  3. CONTRACTOR SHALL PREPARE OR PROVIDE SHOP DRAWINGS AND CALCULATIONS WHEN IT MAKE CHANGES AS PER SITE CONDITION BEFORE PROCEED THE WORK FOR THE APPROVAL OF MOTC ENGINEERING DIVISION.
  4. CONTRACTOR SHALL VERIFY THE ACTUAL SITE CONDITION OF LOCATION AND EXISTING STRUCTURE BEFORE STARTING THE CONSTRUCTION OF THE PROJECT FOR REFERENCE PURPOSE

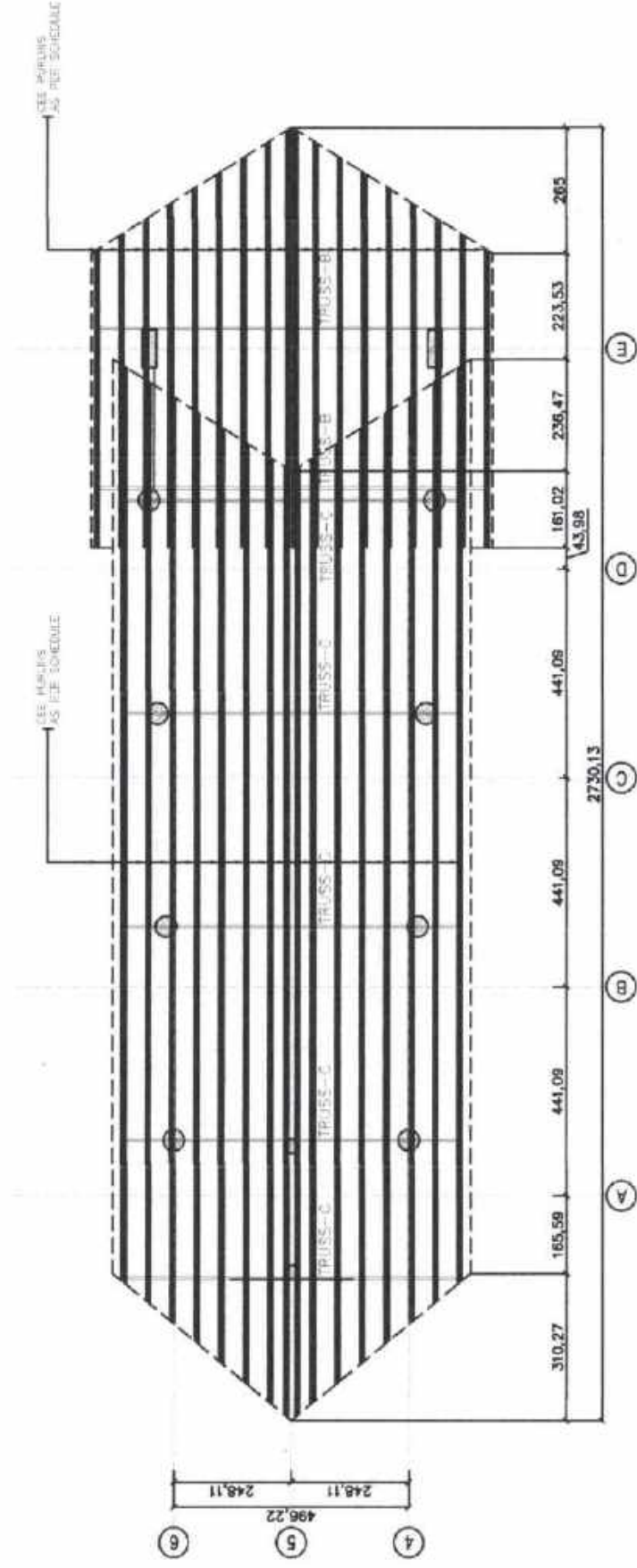

**a** 2ND LEVEL ROOF LAYOUT  
SCALE 1:100

|  |  |   |   |                                  |                       |                         |
|--|--|---|---|----------------------------------|-----------------------|-------------------------|
|  | PROJECT & LOCATION<br>CONSTRUCTION OF RESER LAISS AT<br>LIBUNGAN, TUBERETA, POC ANAGAN, SGA  | SHEET CONTING<br>2ND LEVEL ROOF LAYOUT PLAN | DRAWN<br>SCHEDULED AS PER SCHEDULE<br>ENGRS | CHECKED AND REVIEWED BY<br>ENGRS | SUBMITTED BY<br>ENGRS | SHEET NO.<br>S-12<br>14 |
|  | I AM AN APPROVED ARCHITECT<br>I hereby certify that the drawings and specifications are correct and complete in accordance with the instructions of the client and the requirements of the contract. I am not responsible for any errors or omissions in the drawings or specifications or for any consequences arising therefrom. I have no objection to the use of these drawings and specifications for any other project or purpose. I have no objection to the use of these drawings and specifications for any other project or purpose. I have no objection to the use of these drawings and specifications for any other project or purpose. |   |   |                                  |                       |                         |



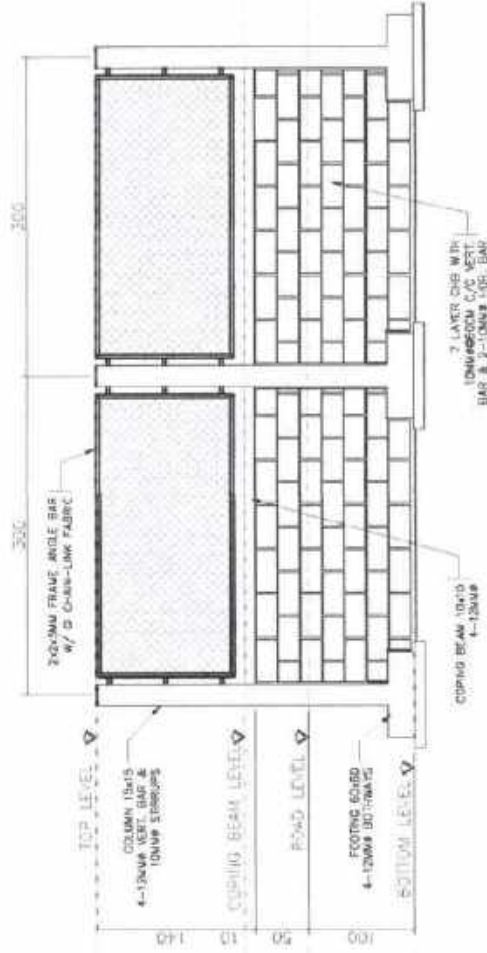

**a** SECTION SCALE N.T.S  
A-2

**b** ELEVATION SCALE N.T.S  
A-2

|   |   |  |   |                         |                             |                     |                     |                         |
|---|---|--|---|-------------------------|-----------------------------|---------------------|---------------------|-------------------------|
|  <p>Ministry of Transportation &amp; Communication<br/>GOVERNMENT OF PUNJAB<br/>PAKISTAN</p> | <p>PROJECT &amp; LOCATION<br/>CONSTRUCTION OF BARRIER LANE AT<br/>LEHJALGAN, TOSPETA, PHEC ANATION, PMA</p> | <p>SHEET CONTENT<br/>FENCE DETAILS</p> | <p>DESIGNED BY: M. HASSAN<br/>CHECKED AND REVISION BY: M. HASSAN<br/>DATE: 10/10/2020</p> | <p>DATE: 10/10/2020</p> | <p>PROJECT NO: S-14B/14</p> | <p>SCALE: N.T.S</p> | <p>SECTION: A-2</p> | <p>DATE: 10/10/2020</p> |
|---|---|--|---|-------------------------|-----------------------------|---------------------|---------------------|-------------------------|



# SANITARY / PLUMBING

1. DRAINAGE LAYOUT PLAN
2. WATER LAYOUT PLAN
3. WATER TANK LAYOUT PLAN
4. PIPING, AND SEPTIC TANK DET.
5. CONNECTION DETAILS



THIS DRAWING IS THE PROPERTY OF MOTIC ENGINEERING DIVISION AND IT CANNOT BE REPRODUCED, COPIED OR CIRCULATED WITHOUT THE WRITTEN CONSENT OF THE MOTIC ENGINEERING DIVISION

**PLUMBING NOTES**

ALL PLUMBING WORKS AND INSTALLATION SHALL BE DONE IN ACCORDANCE WITH THE NATIONAL PLUMBING CODE OF THE PHILIPPINES AND THE LOCAL PLUMBING CODE REQUIRED.

PROVIDE 3/4" DIA. GATE VALVE FOR WATER SUPPLY FROM WATER SOURCE.

ALL PPR, PVC AND CU PIPE TO BE USED SHALL BE BRAND NEW AND HIGH QUALITY STANDARD AND APPROVED FOR BOTH LOCATION AND PURPOSES.

ALL CLEAN OUT SHALL BE FLUSHED MOUNTED ON FLOOR EXCEPT AT AREAS SUBJECT TO TRAFFIC, WHICH SHALL BE FLUSHED TO WALL, PROVIDE COVER CAPS.

THE SLOPE OF SEWER LINE SHALL BE 2% FOR DRAIN LINE, IT SHALL BE 1% THE INLET PIPE SHALL BE 3" HIGHER THAN SYPHON PIPE. PROVIDE VENT AS INDICATED.

ALL PLUMBING WORKS AND INSTALLATIONS SHALL BE DONE UNDER THE DIRECT SUPERVISION OF A LICENSED MASTER PLUMBER.

**LEGEND**

|  |                   |
|--|-------------------|
|  | MANHOLE           |
|  | GULLY-TRAP/P-TRAP |
|  | VENT THROUGH ROOF |
|  | MANHOLE COVER     |
|  | WESTERN CLOSET    |
|  | LAVATORY          |
|  | SHOWER SET        |
|  | FLOOR DRAIN       |
|  | FLOOR CLEAN OUT   |
|  | CLEAN OUT         |

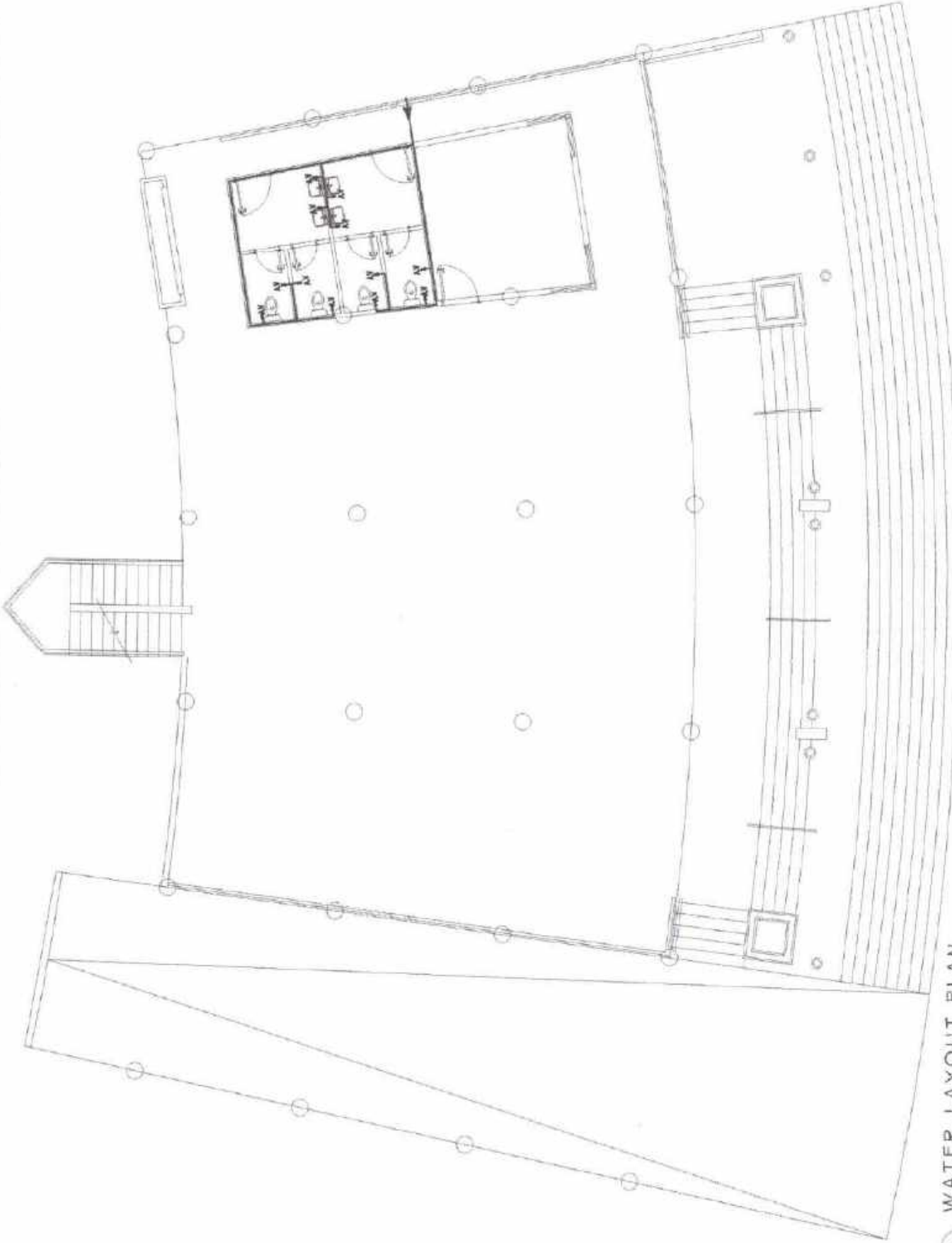

**WATER LAYOUT PLAN**  
SCALE: 1:1000 MTS

|  |   |   |  |  |                               |
|--|---|---|--|--|-------------------------------|
| <br><b>OFFICE OF THE MINISTER</b><br>DEPARTMENT OF TRANSPORTATION AND COMMUNICATIONS | PROJECT TITLE:<br><b>CONSTRUCTION OF REVER LANG AT LUPATUNGAN, TURTETA, PRC, ANAKAP, SCA</b>  | PROJECT NO.:<br><br><b>MICHAEL RANE X. ANAND</b><br>ARCHITECT | CHECKED AND RECORDED BY:<br><br><b>ERIK SISON B. ALCARAZ</b><br>ENGINEER | DRAWN BY:<br><br><b>ENGR. MARICEL G. MASABAL</b><br>ENGINEER | SHEET NO.:<br><b>P-2</b><br>5 |
|  | ALL WORKS REFERENCED HEREON SHALL BE IN ACCORDANCE WITH THE NATIONAL PLUMBING CODE OF THE PHILIPPINES AND THE LOCAL PLUMBING CODE REQUIRED. THE CONTRACTOR SHALL BE RESPONSIBLE FOR OBTAINING ALL NECESSARY PERMITS AND APPROVALS FROM THE APPROPRIATE AGENCIES. THE CONTRACTOR SHALL BE RESPONSIBLE FOR THE PROTECTION OF ALL EXISTING UTILITIES AND STRUCTURES. THE CONTRACTOR SHALL BE RESPONSIBLE FOR THE PROTECTION OF ALL EXISTING UTILITIES AND STRUCTURES. THE CONTRACTOR SHALL BE RESPONSIBLE FOR THE PROTECTION OF ALL EXISTING UTILITIES AND STRUCTURES. |   |  |  |                               |



THIS DRAWING IS THE PROPERTY OF MOTC ENGINEERING DIVISION AND IT CANNOT BE REPRODUCED, COPIED OR CIRCULATED WITHOUT THE WRITTEN CONSENT OF THE MOTC ENGINEERING DIVISION

**PLUMBING NOTES**

ALL PLUMBING WORKS AND INSTALLATION SHALL BE DONE IN ACCORDANCE WITH THE NATIONAL PLUMBING CODE OF THE PHIL. AND THE LOCAL PLUMBING CODE REQUIRED.

PROVIDE 3/4" DR. GATE VALVE FOR WATER SUPPLY FROM WATER SOURCE.

ALL PPR, PVC AND C.I. PIPE TO BE USED SHALL BE BRANDED NEW AND HIGH QUALITY STANDARD AND APPROVED FOR BOTH LOCATION AND PURPOSES.

ALL CLEAN OUT SHALL BE FLUSHED MOUNTED ON FLOOR EXCEPT AT AREAS SUBJECT TO TRAFFIC WHICH SHALL BE FLUSHED TO WALL, PROVIDE COVER CAPS.

THE SLOPE OF SEWER LINE SHALL BE 2% FOR DRAIN LINE, IT SHALL BE 1% THE INLET PIPE SHALL BE 2" HIGHER THAN SIPHON PIPE. PROVIDE VENT AS INDICATED.

ALL PLUMBING WORKS AND INSTALLATIONS SHALL BE DONE UNDER THE DIRECT SUPERVISION OF A LICENSED MASTER PLUMBER.

**LEGEND**

|  |                         |
|--|-------------------------|
|  | MANHOLE                 |
|  | GULLY - TRAP / P - TRAP |
|  | VENT THROUGH ROOF       |
|  | MANHOLE COVER           |
|  | WESTERN CLOSET          |
|  | LAVATORY                |
|  | SHOWER SET              |
|  | FLOOR DRAIN             |
|  | FLOOR CLEAN OUT         |
|  | CLEAN OUT               |

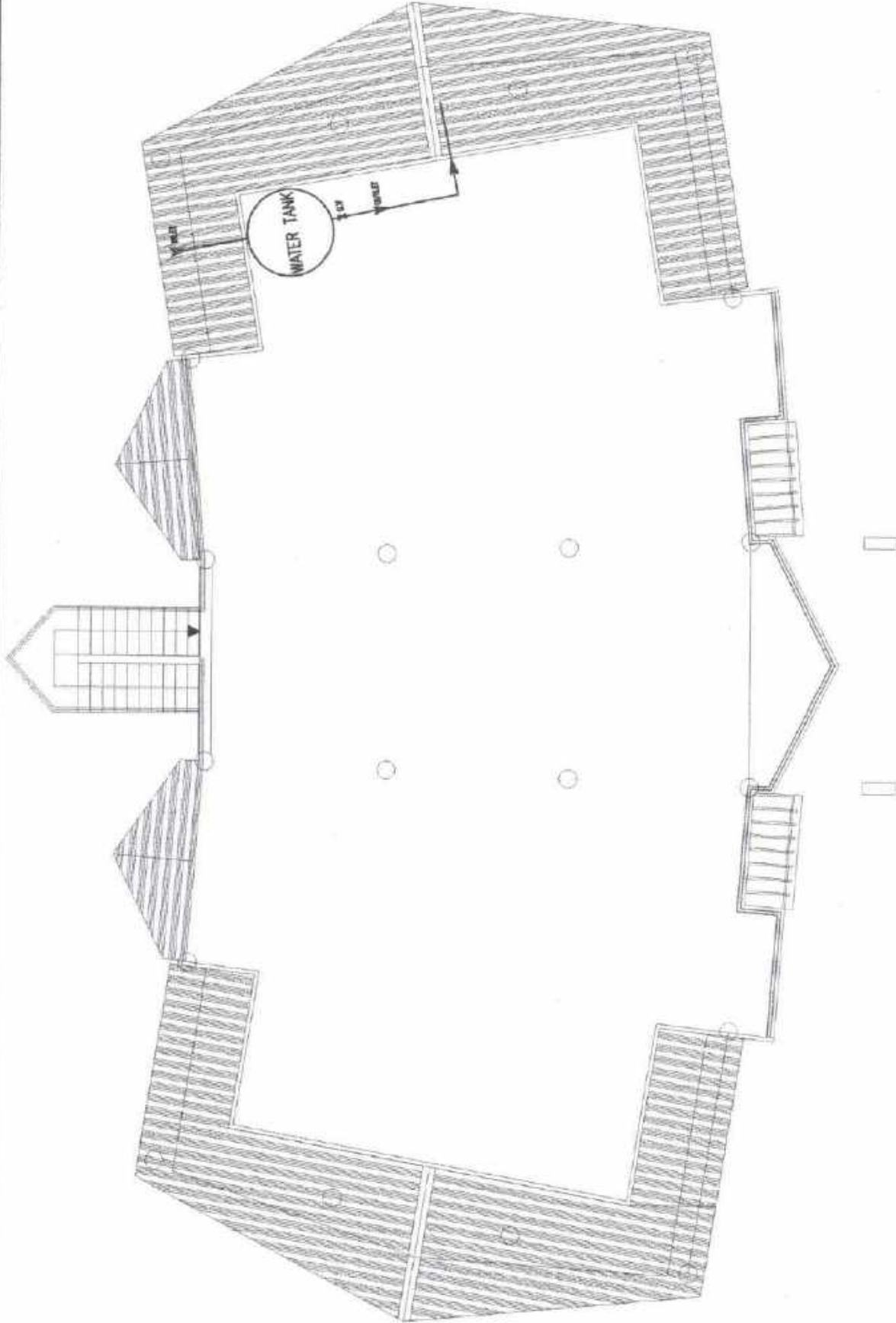

**WATER TANK LAYOUT PLAN**  
SCALE 1:100 MTS

P.3

|  |   |   |   |
|--|---|---|---|
| <p>MINISTRY OF TRANSPORTATION &amp; COMMUNICATION<br/><b>OFFICE OF THE MINISTER</b><br/>BANGKOK<br/>ESTD 1950 (1951)</p> | <p>PROJECT &amp; LOCATION<br/>CONSTRUCTION OF BEVER LANS AT<br/>LUBILOHON, TORRETA, POGUAWAN, DDA</p> | <p>PROJECT CODE<br/>WATER TANK LAYOUT PLAN</p>  | <p>DATE<br/>P-3<br/>5</p>                       |
|  | <p>DESIGNED BY<br/>MCANAGAS, ALAN P. ANOAN<br/>ENGINEER</p>   | <p>CHECKED AND REVIEWED BY<br/>[Signature]<br/>JOS. ESTEBAN D. ALAYZAR<br/>ENGINEER</p> | <p>APPROVED BY<br/>[Signature]<br/>ENGINEER</p> |

THIS DRAWING IS THE PROPERTY OF MOTC ENGINEERING DIVISION AND IT CANNOT BE REPRODUCED, COPIED OR CIRCULATED WITHOUT THE WRITTEN CONSENT OF THE MOTC ENGINEERING DIVISION

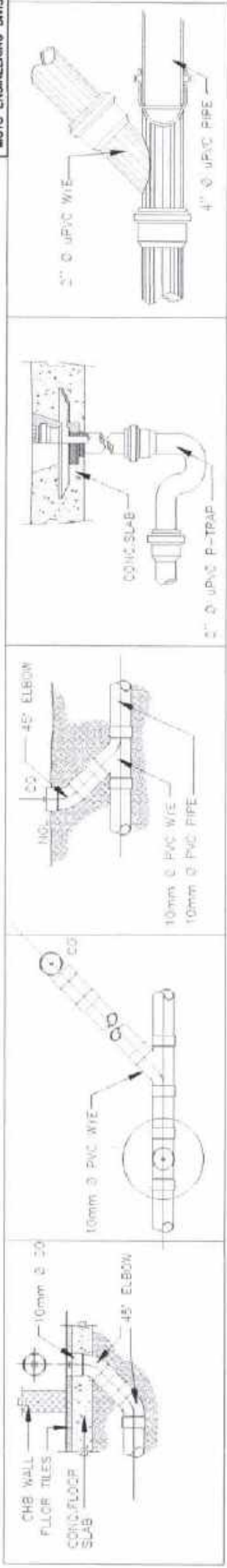

**a CONNECTION AND FITTINGS DETAILS**  
 P-4 SCALE NTS

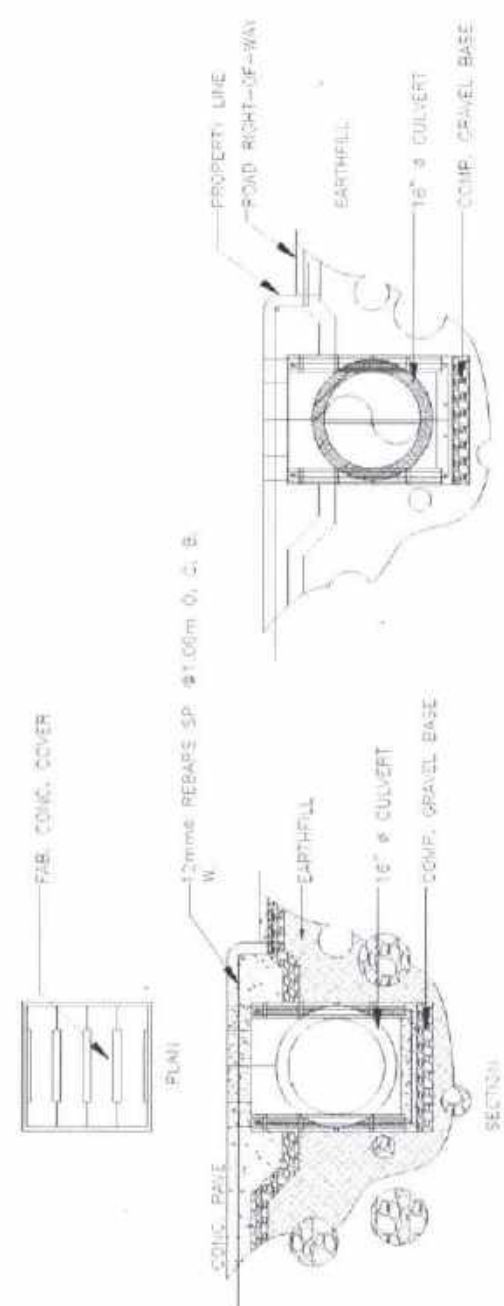

**b DETAILS OF CATCH BASIN/MANHOLE**  
 P-4 SCALE NTS

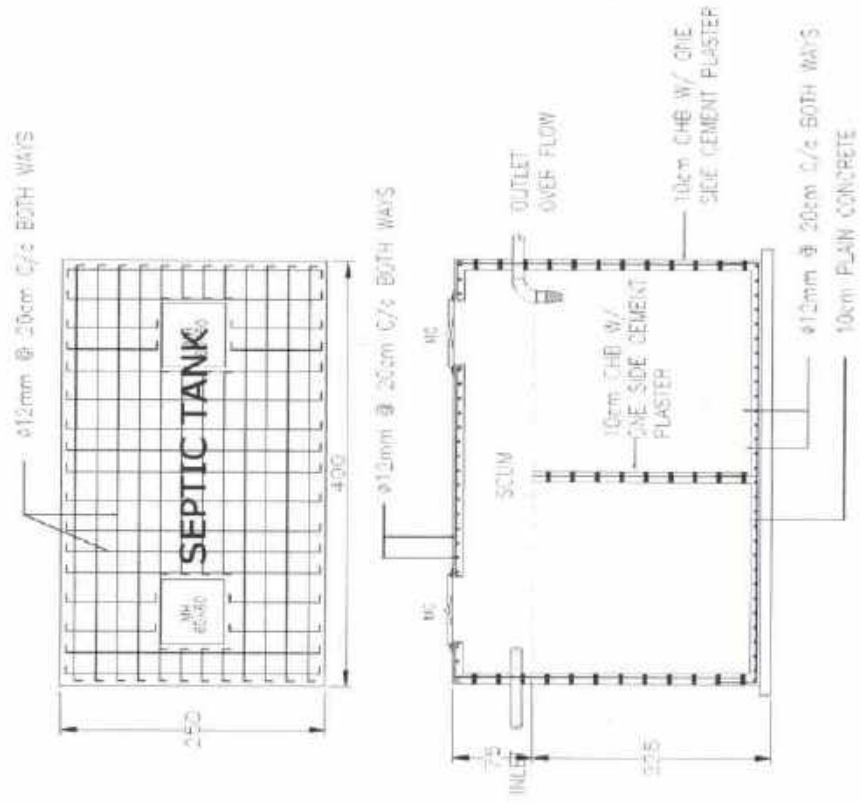

**c STR. DETAILS OF SEPTIC TANK**  
 P-4 SCALE NTS



Ministry of the *Transportation and Communication*  
 MINISTRY OF TRANSPORTATION & COMMUNICATION  
**OFFICE OF THE MINISTER**  
 BANGLADESH  
 Dhaka-1000

PROJECT & LOCATION  
 CONSTRUCTION OF PIPES LINES AT  
 LIEUJIGAN, TORRETA, PINGANGJAL, SGA

SHEET CODE/NO  
 PIPING AND SEPTIC TANK DET.

DATE/NO. OF REVISION  
 Drawings and Specifications are under Contract Documents. Any errors, omissions or omissions in drawings or specifications are the responsibility of the contractor. The contractor shall be responsible for the accuracy of the drawings and specifications. The contractor shall be responsible for the accuracy of the drawings and specifications. The contractor shall be responsible for the accuracy of the drawings and specifications.

DRAWN BY  
 (NAME)  
 CHECKED BY: A. M. UAD  
 (NAME)

CHECKED AND REVIEWED BY  
 (NAME)  
 APPROVED BY: A. M. UAD  
 (NAME)

SUBMITTED BY  
 (NAME)  
 ENGINEER

THIS DRAWING IS THE PROPERTY OF MOTC ENGINEERING DIVISION AND IT CANNOT BE REPRODUCED, COPIED OR CIRCULATED WITHOUT THE WRITTEN CONSENT OF THE MOTC ENGINEERING DIVISION

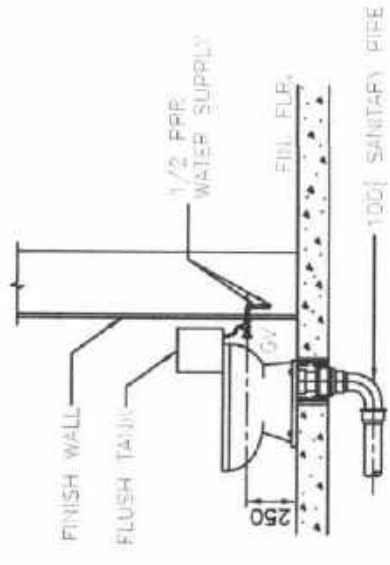

**a** WATER CLOSET INSTALLATION DETAILS  
SCALE: P-5 NTS

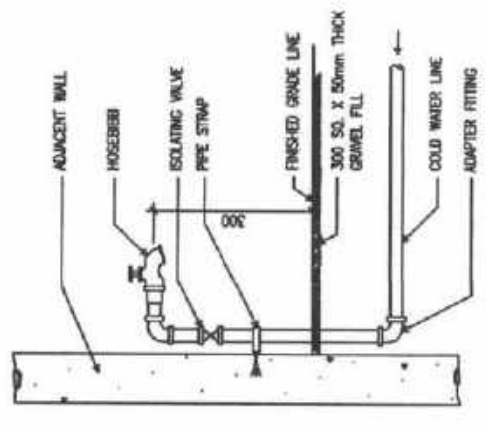

**b** HOSE BIB INSTALLATION DETAILS  
SCALE: P-5 NTS

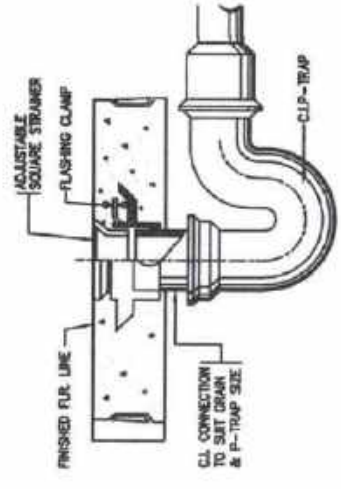

**c** FLOOR DRAIN DETAILS  
SCALE: P-5 NTS

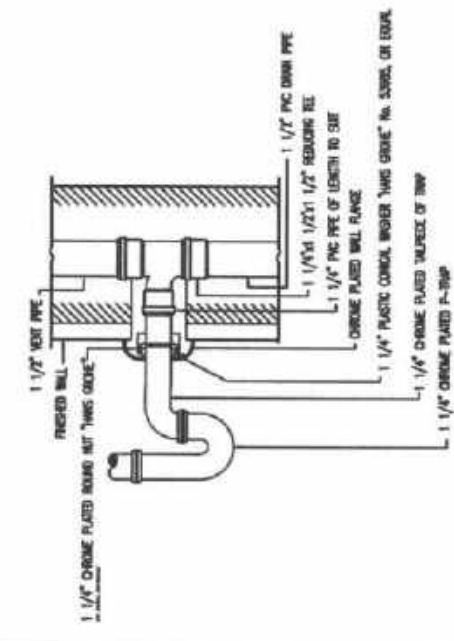

**d** LAV. OUTLET CONNECTION DET.  
SCALE: P-5 NTS

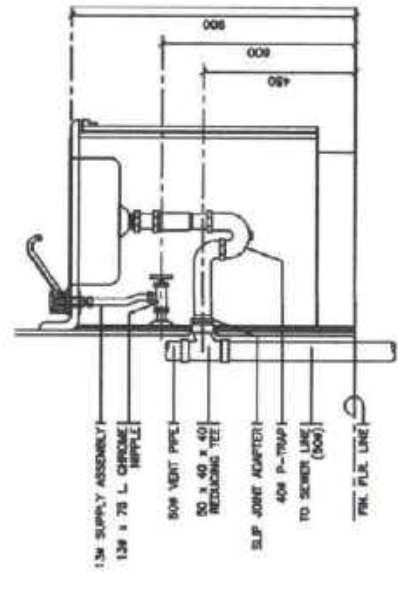

**e** KITCHEN SINK INSTALLATION DETAILS  
SCALE: P-5 NTS

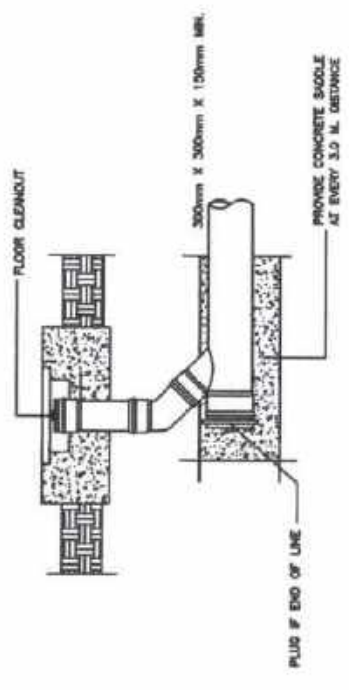

**f** GRND. CLEANOUT DETAILS  
SCALE: P-5 NTS

|  |  |                                     |                                       |  |   |               |
|--|--|-------------------------------------|---------------------------------------|--|---|---------------|
|  | PROJECT'S LOCATION<br>CONSTRUCTION OF REVER LEAD AT<br>LEBUHAN TORRETA, PINGIRANJAN, SGA | SHEET CONTENT<br>CONNECTION DETAILS | DRAWN BY:<br><br>ENGR. S. S. L. S. L. | CHECKED AND REVIEWED BY:<br><br>ENGR. S. S. L. S. L. | SUBMITTED BY:<br><br>ENGR. S. S. L. S. L. | SHEET No.<br> |
|  | PROJECT'S LOCATION<br>CONSTRUCTION OF REVER LEAD AT<br>LEBUHAN TORRETA, PINGIRANJAN, SGA | SHEET CONTENT<br>CONNECTION DETAILS | DRAWN BY:<br><br>ENGR. S. S. L. S. L. | CHECKED AND REVIEWED BY:<br><br>ENGR. S. S. L. S. L. | SUBMITTED BY:<br><br>ENGR. S. S. L. S. L. | SHEET No.<br> |

ELECTRICAL

**SPECIFICATION:**

**GENERAL NOTE:**

1. ALL ELECTRICAL WORKS SHALL COMPLY IN ACCORDANCE WITH THESE PLANS AND SPECIFICATIONS. THE APPLICABLE PROVISIONS OF THE LATEST EDITION OF THE PHILIPPINE ELECTRICAL CODE(PEC) THE RULES AND REGULATION OF THE LOCAL ENFORCING AUTHORITY AND THESE REQUIREMENTS OF THE LOCAL POWER COMPANY. ALL ELECTRICAL WORKS SHALL BE UNDER THE IMMEDIATE SUPERVISION OF A DULY REGISTERED ELECTRICAL ENGINEER.

2. THE ELECTRICAL SERVICE POWER 1-PHASE, 2-WIRE, 230VOLTS AC, 60HZ.

3. WIRING METHOD SHALL BE AS FOLLOWS:

- A. FEEDERS AND RISER- REGIO METALLIC CONDUIT PIPE(RMC)
- B. LIGHTING, POWER - POLYVINYL CHLORIDE CONDUIT PIPE(PVC) RECEPTACLE BRANCH CKT. & AUXILIARY

**GENERAL NOTE:**

4. ALL WIRE SHALL BE COPPER AND THERMOPLASTIC INSULATED TYPE THIN UNLESS OTHERWISE INDICATED IN THE PLAN. THE MINIMUM SIZE OF WIRE FOR POWER AND LIGHTING CIRCUIT HOMERUN SHALL BE 3.5MM SQUARE AND INSULATED FOR 600VOLTS. SMALLEST RACEWAY SHALL BE 15MM CONDUIT TRADE/NOMINAL SIZE.

5. ALL OUTLET BOXES SHALL BE GALVANIZE GAUGE NO. 16 DEEP WITH FACTORY KNOCKOUTS.

6. ALL MATERIALS TO BE USED SHALL BE BRAND NEW AND APPROVED TYPE FOR THE PARTICULAR LOCATION AND PURPOSE.

7. GROUNDING SYSTEM SHALL BE PROVIDED TO ALL LIGHTING AND POWER CIRCUIT AS PER PHILIPPINE ELECTRICAL CODE REQUIREMENT.

**GENERAL NOTE:**

- 8. MOUNTING HEIGHT OF WIRING DEVICES SHALL BE AS FOLLOWS:
  - A. LIGHT SWITCH -1.20M ABOVE THE FINISH FLOOR
  - B. CONVENIENCE OUTLET -0.3M ABOVE THE FINISH FLOOR
  - C. SAFETY SWITCH -1.80M ABOVE THE FINISH FLOOR
  - D. EVERY OVER 10M FROM THE SOURCE MUST ADD ONE STEP WIRE

**LEGEND:**

| SYMBOL | DESCRIPTION                          |
|--------|--------------------------------------|
|        | CEILING LIGHT OUTLET                 |
|        | 4 FEET FLUORESCENT LAMP              |
|        | ON/OFF SWITCH                        |
|        | THREE WAY SWITCH                     |
|        | CONVENIENCE OUTLET                   |
|        | AIR CONDITIONING UNIT OUTLET         |
|        | LIGHTING PANEL BOARD                 |
|        | POWER LOAD PANEL BOARD               |
|        | WALL LAMP                            |
|        | RACEWAY CONDUIT CONCEALED IN CEILING |
|        | RACEWAY CONDUIT CONCEALED UPPER FL   |
|        | ELECTRIC SERVICE METER KWH           |
|        | SERVICE ENTRANCE                     |

**LOAD SCHEDULE:**

**LIGHTING LOADS**

| BRANCH DESCRIPTION | QUANTITY | WATTAGE PER UNIT | TOTAL WATTAGE | NO. OF CIRCUITS | WIRE SIZE (150% OF LOAD) | CONDUIT SIZE (150% OF LOAD) |
|--------------------|----------|------------------|---------------|-----------------|--------------------------|-----------------------------|
| 1. OFF LIGHTING    | 20       | 270              | 5400          | 12              | 1.5                      | 15mm                        |
| 2. OFF LIGHTING    | 20       | 270              | 5400          | 12              | 1.5                      | 15mm                        |
| 3. OFF LIGHTING    | 12       | 270              | 3240          | 12              | 1.5                      | 15mm                        |
| 4. OFF LIGHTING    | 27       | 270              | 7290          | 12              | 1.5                      | 15mm                        |

**POWER LOADS**

| BRANCH DESCRIPTION | QUANTITY | VOLTAGES PER UNIT | TOTAL VOLTAGE | NO. OF CIRCUITS | WIRE SIZE (150% OF LOAD) | CONDUIT SIZE (150% OF LOAD) |
|--------------------|----------|-------------------|---------------|-----------------|--------------------------|-----------------------------|
| 1. OFF POWER       | 1        | 100               | 100           | 1               | 1.5                      | 15mm                        |
| 2. OFF POWER       | 1        | 100               | 100           | 1               | 1.5                      | 15mm                        |
| 3. OFF POWER       | 1        | 100               | 100           | 1               | 1.5                      | 15mm                        |
| 4. OFF POWER       | 1        | 100               | 100           | 1               | 1.5                      | 15mm                        |
| 5. OFF POWER       | 1        | 100               | 100           | 1               | 1.5                      | 15mm                        |
| 6. OFF POWER       | 1        | 100               | 100           | 1               | 1.5                      | 15mm                        |
| 7. OFF POWER       | 1        | 100               | 100           | 1               | 1.5                      | 15mm                        |
| 8. OFF POWER       | 1        | 100               | 100           | 1               | 1.5                      | 15mm                        |

UNBALANCED LOADS  
 LIGHTING LOAD = 2700  
 POWER LOAD = 800  
 TOTAL LOAD = 3500  
 WIRE SIZE = 15mm

UNBALANCED LOADS  
 LIGHTING LOAD = 2700  
 POWER LOAD = 800  
 TOTAL LOAD = 3500  
 WIRE SIZE = 15mm

**SAFETY SWITCH:**

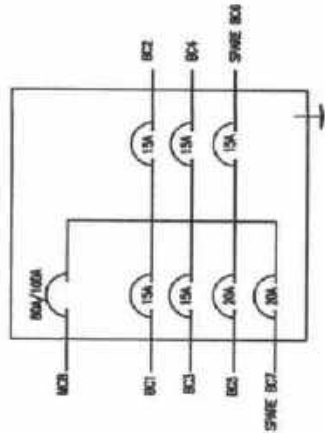

**RISER DIAGRAM**

1-15MM SQ THIN CU IN 15MM SQ C  
 1-15MM SQ X 2400MM LENGTH  
 GROUNDING ROD COPPERWELD

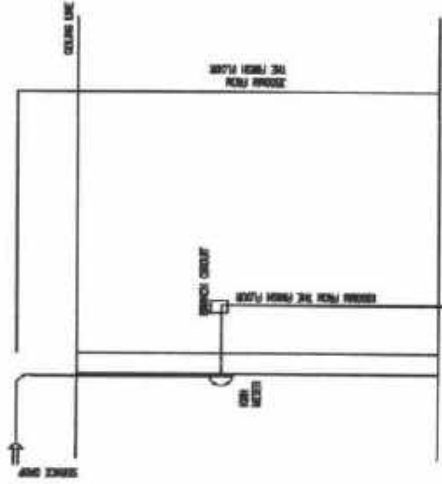

Ministry of Transportation & Communication  
**OFFICE OF THE MINISTER**  
 BARANGAY  
 COTABATO CITY

PROJECT'S LOCATION  
 CONSTRUCTION OF RIVER LANDING  
 at Libuganan, Torreta, Pigcawayan, SGA

SHEET CONTENT  
 SPECIFICATION, LEGEND,  
 LOAD SCHEDULE, SAFETY  
 SWITCH, RISER DIAGRAM

DESIGNED BY: [Signature]  
 ENGINEER RANUJ P. REYES  
 USA-CERTIFIED  
 ENGINEER

CHECKED AND REVIEWED BY: [Signature]  
 ENGINEER D. ALANSON  
 REGISTERED PROFESSIONAL  
 ENGINEER

APPROVED BY: [Signature]  
 ENGINEER HENRY B. TORRES  
 REGISTERED PROFESSIONAL  
 ENGINEER

SHEET NO.  
 E-01  
 05

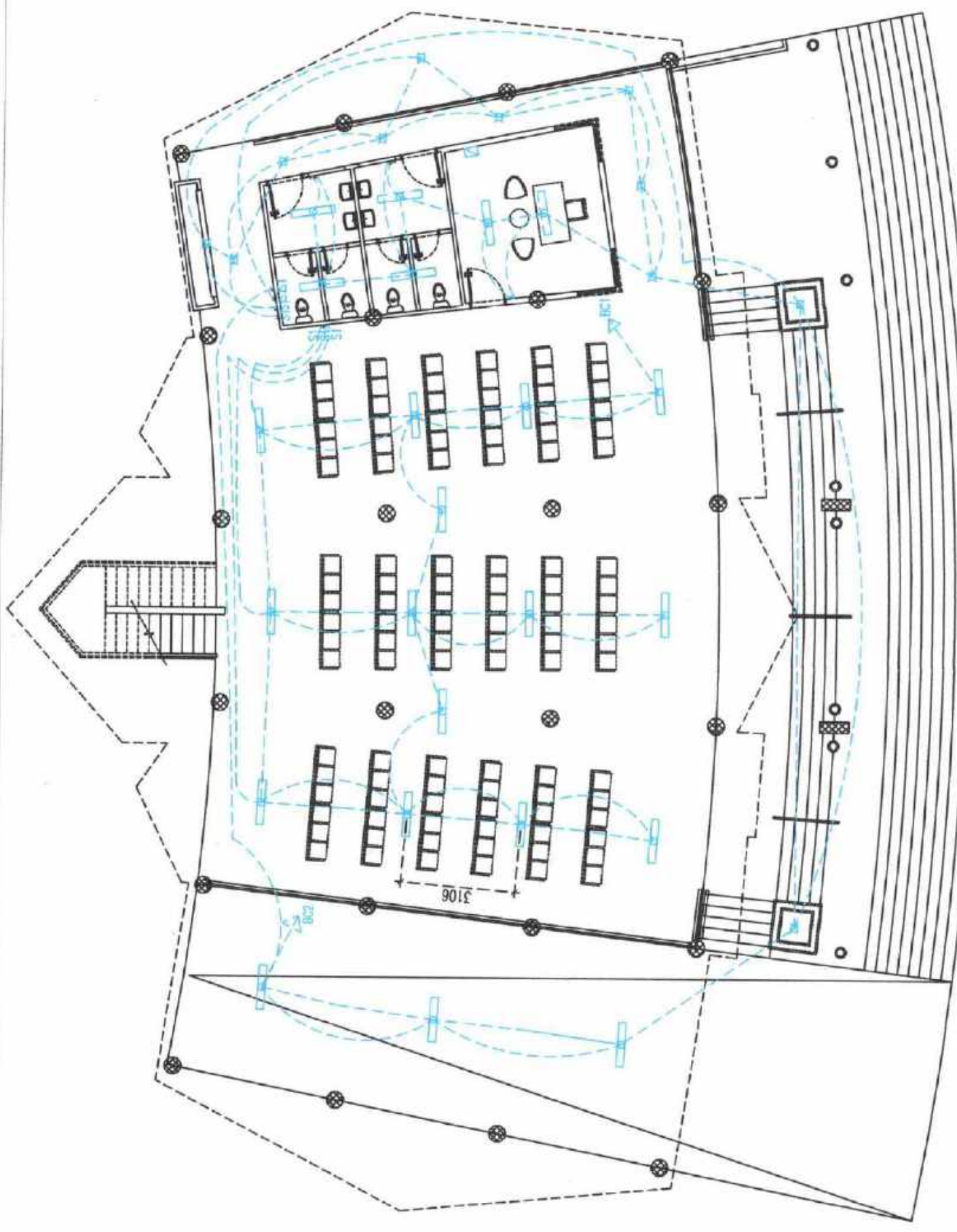

|  |   |   |   |  |  |  |  |
|--|---|---|---|--|--|--|--|
|  <p>REPUBLIC OF INDONESIA<br/>MINISTRY OF TRANSPORTATION &amp; COMMUNICATION<br/><b>OFFICE OF THE MINISTER</b><br/>BARUMI<br/>COTABATO CITY</p> | <p>PROJECT LOCATION<br/><b>CONSTRUCTION OF RIVER LANDING</b><br/>at Libungan, Torreta, Pigawayan, SGA</p> | <p>SHEET CONTENT<br/><b>ELECTRICAL LIGHTING FOR</b><br/><b>GROUND FLOOR</b></p> | <p>REVISIONS, NOTES, SPECIFICATIONS<br/>Changes and Specifications after Contract Documents may occur. All changes shall be indicated by a circled number in the Contract Documents and a circled number in the Specifications. The Engineer shall be responsible for any errors in the Contract Documents or Specifications. The Engineer shall be responsible for the accuracy of all dimensions for use in the construction of the project. The Engineer shall be responsible for the accuracy of all dimensions for use in the construction of the project.</p> | <p>PREPARED BY<br/><i>[Signature]</i><br/><b>RANDI T. ALIBONER</b><br/>ELECTRICAL ENGINEER</p> | <p>CHECKED AND REVIEWED BY<br/><i>[Signature]</i><br/><b>JOSEF MARIFIA D. ALABGAR</b><br/>REGISTERED ELECTRICAL ENGINEER</p> | <p>SUBMITTED BY<br/><i>[Signature]</i><br/><b>ENGR. HENRIETTA B. TORREALA</b><br/>REGISTERED ELECTRICAL ENGINEER</p> | <p>SHEET No.<br/><b>E-02</b><br/><b>05</b></p> |
|--|---|---|---|--|--|--|--|

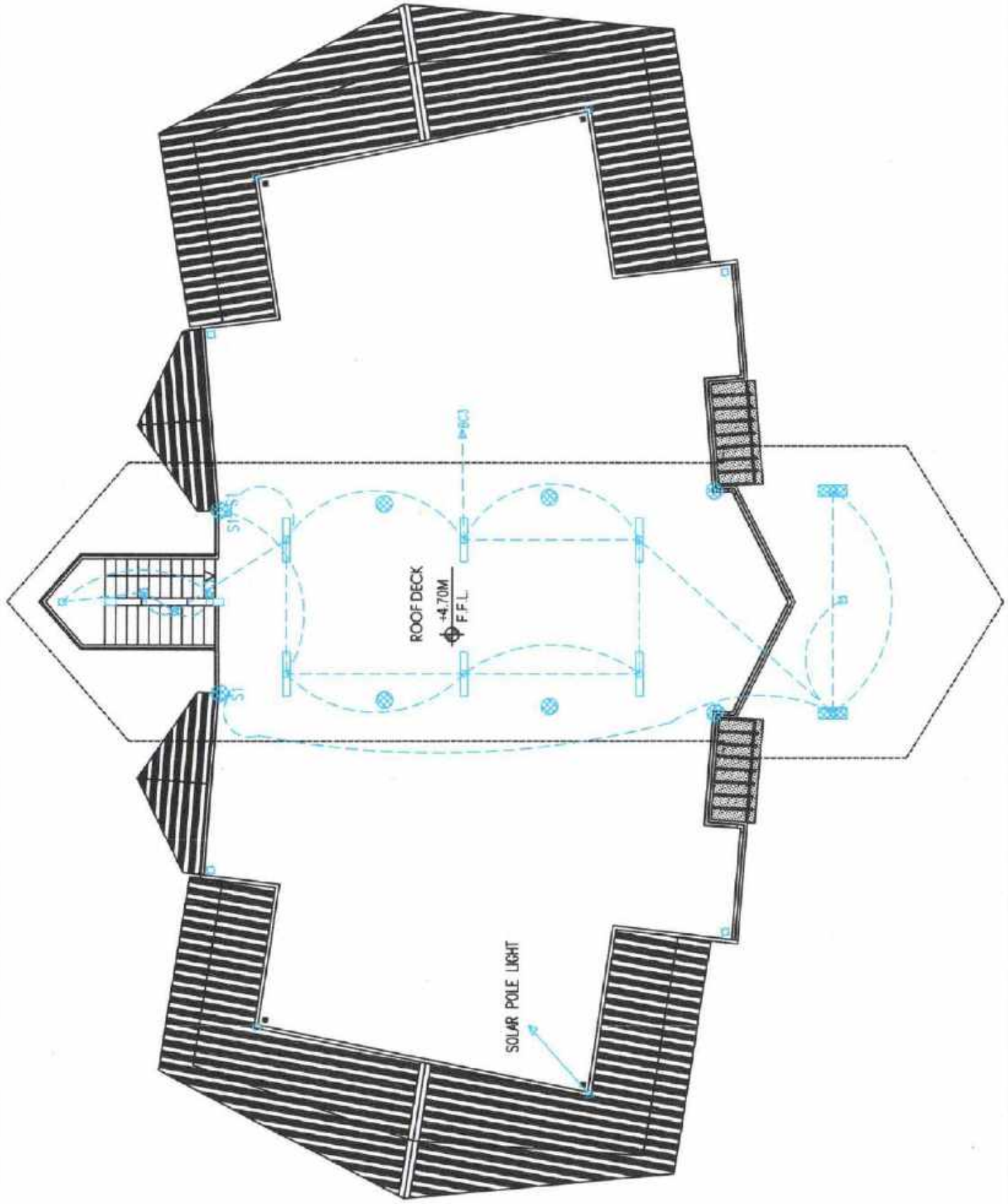

|  |  |   |   |   |   |                                     |
|--|--|---|---|---|---|-------------------------------------|
|  <p> <b>Office of the Minister</b><br/>         DEPARTMENT OF TRANSPORTATION &amp; COMMUNICATIONS<br/>         REPUBLIC OF THE PHILIPPINES       </p> | <p>PROJECT &amp; LOCATION</p> <p>CONSTRUCTION OF RIVER LANDING<br/>at Libungan, Torreta, Pigcawayan, SGA</p> | <p>SHEET CONTENTS</p> <p>ELECTRICAL LIGHTING FOR<br/>SECOND FLOOR</p> | <p>PREPARED BY:</p> <p><i>Randy T. Arbec</i><br/>RANDY T. ARBEC (REG. ENG.)<br/>ELECTRICAL ENGINEER</p> | <p>CHECKED AND APPROVED BY:</p> <p><i>Engr. Arkhyia D. Alangar</i><br/>ENGR. ARKHYIA D. ALANGAR<br/>ENGINEER II</p> | <p>SUBMITTED BY:</p> <p><i>Engr. Nasibuddin T. Madaya</i><br/>ENGR. NASIBUDDIN T. MADAYA<br/>ENGINEER</p> | <p>SHEET NO.</p> <p>E-03<br/>05</p> |
|--|--|---|---|---|---|-------------------------------------|

IN CASE OF AMENDMENT TO THE ORIGINAL DRAWING, THE ENGINEER SHALL BE RESPONSIBLE FOR THE CORRECTIONS AND FOR THE CLARIFICATION OF THE SAME. THE ENGINEER SHALL BE RESPONSIBLE FOR THE CORRECTIONS AND FOR THE CLARIFICATION OF THE SAME. THE ENGINEER SHALL BE RESPONSIBLE FOR THE CORRECTIONS AND FOR THE CLARIFICATION OF THE SAME.

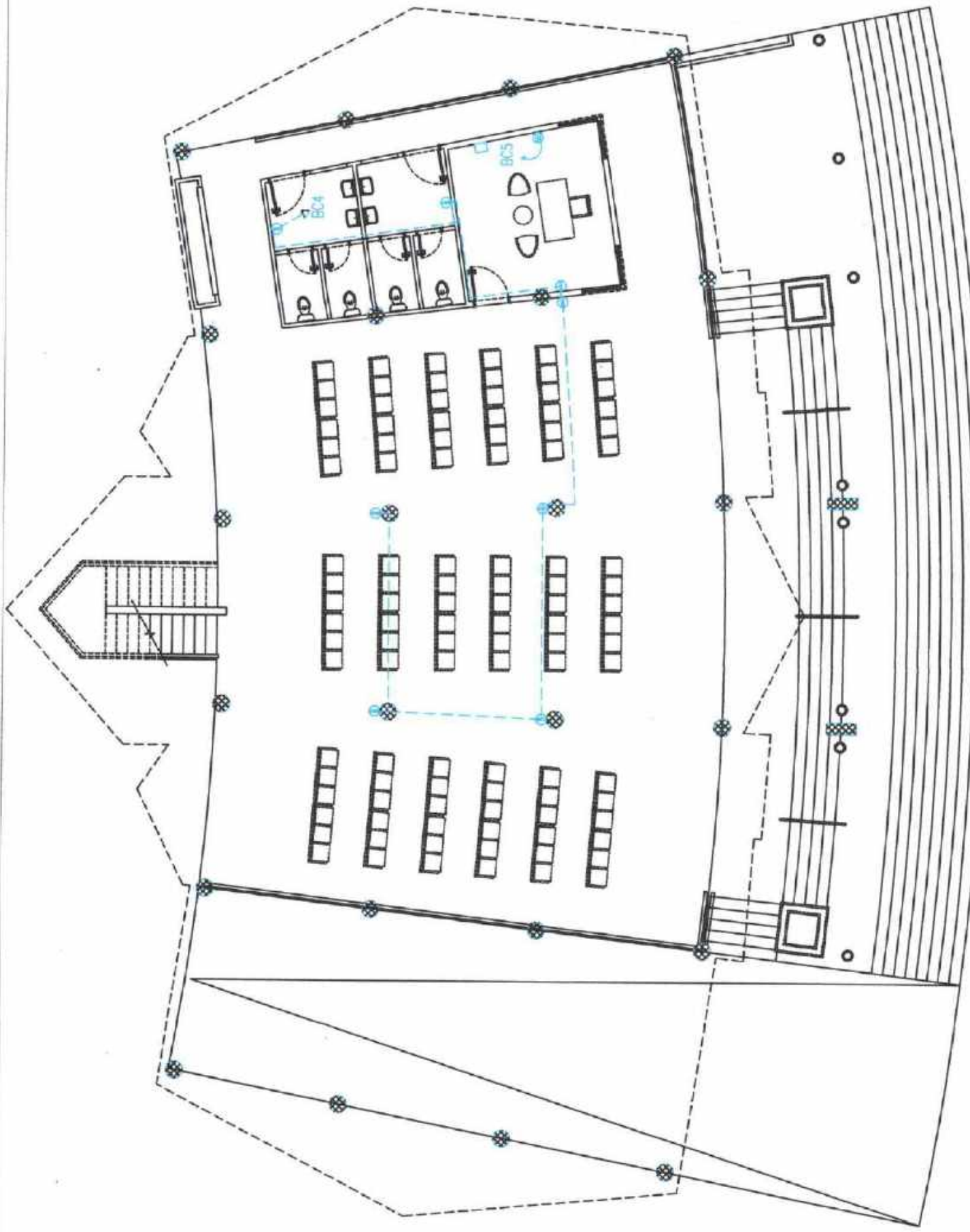

|   |   |  |  |   |   |  |   |
|---|---|--|--|---|---|--|---|
|  <p> <b>Office of the Minister</b><br/>         DEPARTMENT OF TRANSPORTATION AND COMMUNICATION<br/>         CEBU CITY       </p> | <p> <b>PROJECT LOCATION:</b><br/>         CONSTRUCTION OF RIVER LANDING<br/>         at Libugan, Torreta, Pigawayan, SGA       </p> | <p> <b>SHEET CONTAINS:</b><br/>         ELECTRICAL POWER OUTLET<br/>         FOR GROUND FLOOR       </p> | <p> <b>REVISIONS, ARTICLE INSTRUCTIONS:</b><br/>         Changes and Specifications and other Contract Documents by which the Design is made, with the exception of those which are indicated in the Contract Documents, shall be subject to the approval of the Architect, who shall be responsible for any errors or omissions in the Contract Documents by which the quality of work is affected, whether such errors or omissions are made by the Architect or by the contractor.       </p> | <p> <b>DESIGNED BY:</b><br/> <br/>         RANCE T. ALIBON<br/>         ELECTRICAL ENGINEER       </p> | <p> <b>CHECKED AND REVIEWED BY:</b><br/> <br/>         ENGR. JENNIFER D. ALIPOG<br/>         ENGINEER       </p> | <p> <b>SUBMITTED BY:</b><br/> <br/>         ENGINEER       </p> | <p> <b>SHEET NO.</b><br/>         E-04<br/>         05       </p> |
|---|---|--|--|---|---|--|---|



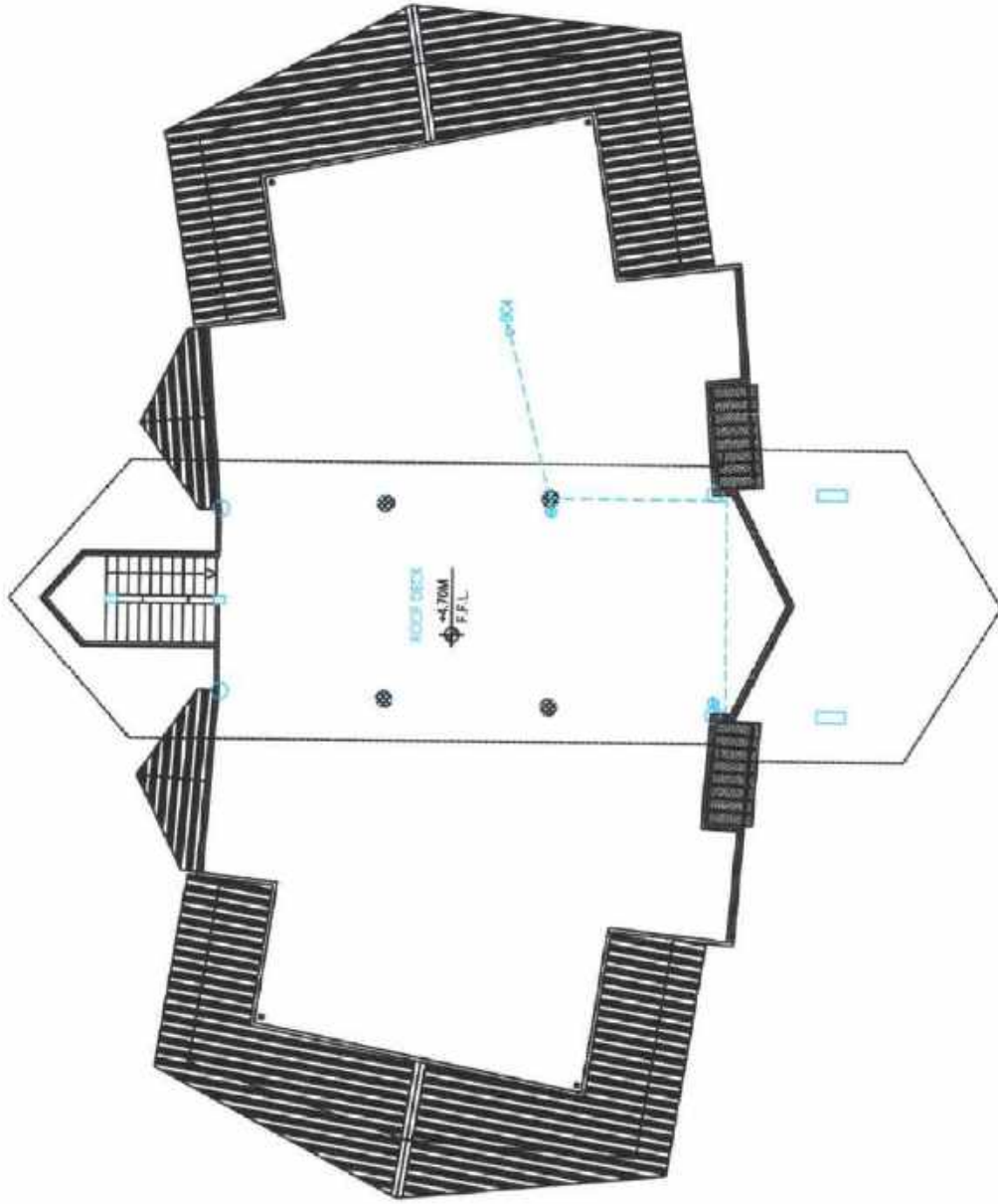

|  |   |   |  |   |   |  |                                  |
|--|---|---|--|---|---|--|----------------------------------|
|  | <p>PROJECT LOCATION:<br/><b>CONSTRUCTION OF RIVER LANDING</b><br/>at Libungan, Torreta, Pigcawayan, SGA</p> | <p>SHEET DATE(S):<br/><b>ELECTRICAL POWER OUTLET FOR SECOND FLOOR</b></p> | <p>MAJOR APPLICABLE REVISIONS:<br/>Change and Specifications and other Contract Documents, Additions, Deletions or modifications to the Contract Documents, are the responsibility of the Architect, and the responsibility of the Architect to make the necessary amendments to the Contract Documents for any purpose to be made in accordance with the Contract Documents, unless otherwise specified in writing by the Architect or the Architect's Author of said Contract Documents.</p> | <p>PREPARED BY:<br/><br/>RANCHO T. ALIBONAR<br/>ELECTRICAL ENGINEER</p> | <p>CHECKED AND REVIEWED BY:<br/><br/>ENGR. ABYRHIA D. ALIBONAR<br/>ENGINEER</p> | <p>SUBMITTED BY:<br/><br/>ENGR. ABYRHIA D. ALIBONAR<br/>ENGINEER</p> | <p>SHEET NO:<br/>E-05<br/>05</p> |
|--|---|---|--|---|---|--|----------------------------------|